

PAN9028

Wi-Fi Dual Band 2.4 GHz/5 GHz and Bluetooth® Module Product Specification

Rev. 1.8

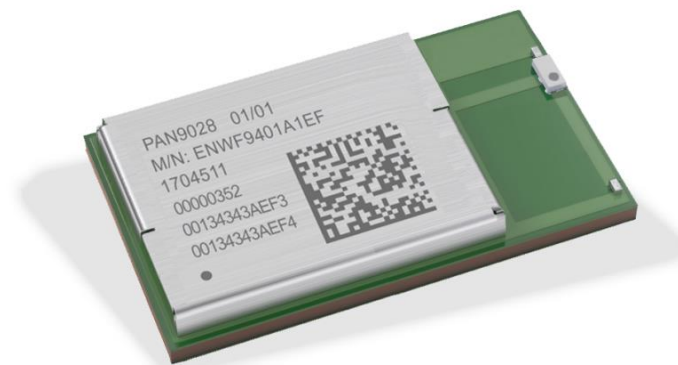

Overview

The PAN9028 is a 2.4 GHz and 5 GHz ISM band Wi-Fi and Bluetooth radio module, which includes a wireless radio and a power management IC for easy integration of Wi-Fi and Bluetooth connectivity into various electronic devices.

Features

- Dual band 2.4 GHz/5 GHz 802.11 a/b/g/n/ac Wi-Fi/Bluetooth combo module
- The hardware is capable of WPA3 and supports 802.11i security standards through AES and CCMP
- 802.11e Quality of Service is supported for multimedia application
- IEEE 802.11ac (Wave 2), 1×1 spatial stream with data rates up to 433 Mbps (MCS9, 80 MHz channel bandwidth)
- IEEE 802.11ac MU-MIMO beamformee
- Bluetooth 5.2 (includes Low Energy)
- Dual simultaneous and independent WLAN and Bluetooth operation
- Coexistence interface for arbitration of co-located WLAN, Bluetooth, or mobile wireless system (e.g. LTE or ZigBee®)
- Generic interfaces include SDIO 3.0 and high-speed UART for host processor connection
- Software driver Linux®

Characteristics

- Surface Mount Type (SMT):
24 mm × 12 mm × 2.73 mm
- NXP® 88W8987 WLAN 2.4 GHz/5 GHz and Bluetooth single-chip solution inside
- Single power supply: 3.3 V with NXP PM823 Power Management IC (optional)
- Tx power: 16 dBm at 802.11b
- Rx sensitivity: -97 dBm at 802.11b DSSS 1 Mbps
- IEEE 802.11ac 20 MHz, 40 MHz, 80 MHz channel bandwidth
- Long and Short Guard Interval support
- Current consumption Wi-Fi typical 320 mA (at Tx) and 70 mA (at Rx)
- SDIO 1 bit or 4 bit
- Wide temperature range of -30 °C to 85 °C

Block Diagram

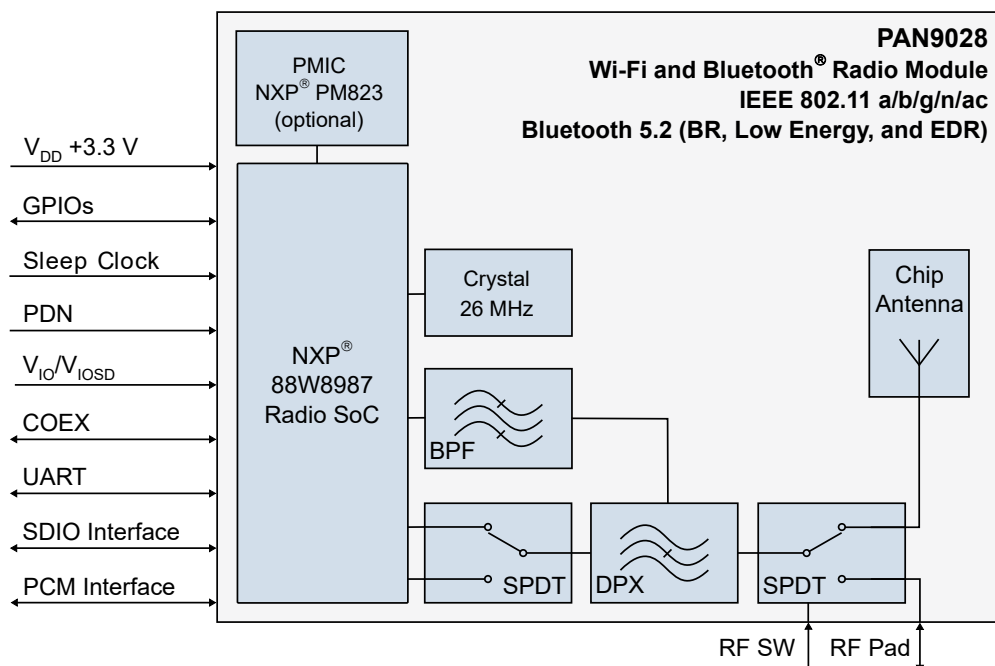

By purchase of any of the products described in this document the customer accepts the document's validity and declares their agreement and understanding of its contents and recommendations. Panasonic Industrial Devices Europe GmbH (Panasonic) reserves the right to make changes as required at any time without notification. Please consult the most recently issued Product Specification before initiating or completing a design.

© Panasonic Industrial Devices Europe GmbH 2025.

This specification sheet is copyrighted. Reproduction of this document is permissible only if reproduction is without alteration and is accompanied by all associated warranties, conditions, limitations, and notices. Do not disclose it to a third party.

All rights reserved.

This Product Specification does not lodge the claim to be complete and free of mistakes.

If this document is marked as preliminary, please be aware that its final content is not yet concluded and the use of it is at your own risk.

Document Acceptance

By signing the Product Specification, you acknowledge that you are a legal representative for your company and that you understand and accept the validity of the contents herein.

If the signed version of the Product Specification has not been returned to Panasonic within 30 days after receipt of the product, the specification or approval sheet shall be deemed to be accepted by you.

Engineering Samples (ES)

If Engineering Samples are delivered to the customer, these samples have the status "Engineering Samples". This means that the design of this product is not yet concluded. Engineering Samples may be partially or fully functional, and they may differ from the published Product Specification.

Engineering Samples are not qualified and they are not to be used for reliability testing or series production.

Disclaimer

The customer acknowledges that samples may deviate from the Product Specification and may bear defects due to their status of development and the lack of qualification mentioned above.

Panasonic rejects any liability or product warranty for Engineering Samples. In particular, Panasonic disclaims liability for damages caused by:

- The use of the Engineering Sample other than for evaluation purposes, particularly the installation or integration in another product to be sold by the customer,
- Deviation or lapse in function of the Engineering Sample,
- Improper use of the Engineering Sample.

Panasonic Industrial Devices Europe GmbH disclaims any liability for consequential and incidental damages. In case of any queries regarding the Engineering Samples, please contact your local sales partner or the related product manager.

Information on Software

The PAN9028 module does not contain any software ex works, i.e. software is provided by 3rd party suppliers only. The essential software resources can be found on the partner website of NXP Semiconductors <https://www.nxp.com/>.

PIDEU provides a factory software programming service for your customized firmware; for further information please reach out to your local sales contact this regarding ⇒ [7.2.1 Contact Us](#).

Table of Contents

1	About This Document	6
1.1	Purpose and Audience	6
1.2	Revision History.....	6
1.3	Use of Symbols	7
1.4	Related Documents	7
2	Overview	8
2.1	Block Diagram	9
2.2	Pin Configuration	10
2.3	Host Interface	18
2.4	Peripheral Bus Interfaces	18
2.5	PCM Interfaces.....	19
2.6	Coexistence.....	19
2.7	WLAN	29
2.8	Bluetooth	37
3	Detailed Description	39
3.1	Dimensions.....	39
3.2	Footprint	40
3.3	Packaging.....	41
3.4	Case Marking	44
4	Specification	45
4.1	Default Test Conditions	45
4.2	Absolute Maximum Ratings.....	45
4.3	Recommended Operating Conditions.....	46
4.4	Current Consumption.....	48
4.5	Internal Operating Frequencies	52
4.6	External Sleep Clock Specifications	53
4.7	Power-up Sequence	53
4.8	Power-down Sequence.....	54
4.9	Power Good (for Module Variant ENWF940[x]A1EF).....	55
4.10	Interfaces.....	55
4.11	RF Electrical Characteristics.....	65
4.12	Reliability Tests	79
4.13	Recommended Soldering Profile	80
5	Cautions	81
5.1	Design Notes	81
5.2	Installation Notes	81
5.3	Usage Condition Notes.....	82
5.4	Storage Notes.....	82
5.5	Safety Cautions	83
5.6	Other Cautions	83
5.7	Restricted Use	84

- 6 Regulatory and Certification Information85**
 - 6.1 Federal Communications Commission (FCC) for US85
 - 6.2 Innovation, Science, and Economic Development (ISED) for Canada90
 - 6.3 European Conformity According to RED (2014/53/EU)98
 - 6.4 United Kingdom Conformity According to Statutory Instrument SI 2017/1206.....101
 - 6.5 Bluetooth102
 - 6.6 RoHS and REACH Declaration103

- 7 Appendix104**
 - 7.1 Ordering Information.....104
 - 7.2 Contact Details105

1 About This Document

1.1 Purpose and Audience

This Product Specification provides details on the functional, operational, and electrical characteristics of the Panasonic PAN9028 module. It is intended for hardware design, application, and Original Equipment Manufacturers (OEM) engineers.



The product is referred to as “PAN9028” and “module” within this document.

Unless otherwise stated, the data in this document is valid for all module variants.

1.2 Revision History

Revision	Date	Modifications/Remarks
1.0	2021-08-24	First version
1.1	2021-08-26	<ul style="list-style-type: none"> Updated ⇒ 6 Regulatory and Certification Information Updated layout
1.2	2021-10-13	<ul style="list-style-type: none"> Corrected FCC ID ⇒ 6 Regulatory and Certification Information Updated Power Management IC Updated Bluetooth version
1.3	2022-05-13	<ul style="list-style-type: none"> Added new antennas ⇒ 6.1.5 Approved Antenna List Updated ⇒ 6.2 Innovation, Science, and Economic Development (ISED) for Canada Updated ⇒ 7.1 Ordering Information
1.4	2022-05-25	Corrected frequency band for Class 2 ⇒ 6.3.2 Equipment Classes
1.5	2023-10-11	<ul style="list-style-type: none"> Removed IEEE 802.11mc and DRCS (dynamic rapid channel switching) – not supported by firmware anymore. Changed descriptions for pins A2, A3, A10, B2, B6, B7, E6, G1, G2, G4 and added footnotes for pins F8 and F9 ⇒ 2.2 Pin Configuration Updated ENW number ⇒ 3.4 Case Marking Updated ⇒ 4.12 Reliability Tests Added overview of certifications ⇒ 6 Regulatory and Certification Information Added ⇒ 6.4 United Kingdom Conformity According to Statutory Instrument SI 2017/1206 Added “ENWF9408AMEF” ⇒ 7.1 Ordering Information
1.6	2024-07-11	<ul style="list-style-type: none"> Corrected notified Body ID from “0682” to “0681” ⇒ 6.3 European Conformity According to RED (2014/53/EU) ⇒ 6.4 United Kingdom Conformity According to Statutory Instrument SI 2017/1206 Added table for 2.4 GHz channels ⇒ Channel Tables based on Regulatory Domain/Country
1.7	2024-09-12	Updated ⇒ Control Pin Function for all Module Variants : Strap value “1” is no longer supported by the current firmware and driver releases.
1.8	2025-07-29	<ul style="list-style-type: none"> Updated certification information for RED ⇒ 6.3 European Conformity According to RED (2014/53/EU) Changed MOQ for module ⇒ 7.1 Ordering Information

1.3 Use of Symbols

Symbol	Description
	<p>Note</p> <p>Indicates important information for the proper use of the product. Non-observance can lead to errors.</p>
	<p>Attention</p> <p>Indicates important notes that, if not observed, can put the product's functionality at risk.</p>
⇒ [chapter number] [chapter title]	<p>Cross reference</p> <p>Indicates cross references within the document.</p> <p>Example:</p> <p>Description of the symbols used in this document ⇒ 1.3 Use of Symbols.</p>

1.4 Related Documents

For related documents please refer to the Panasonic website ⇒ [7.2.2 Product Information](#).

2 Overview

The PAN9028 is a dual band 2.4 GHz and 5 GHz 802.11 a/b/g/n/ac Wi-Fi radio module with integrated Bluetooth BR/EDR/Low Energy (LE), specifically designed for highly integrated and cost-effective applications. The simultaneous and independent operation of the two standards enables very high data rates (802.11ac) and low-power operation (Bluetooth LE). Integrated power management, a fast dual-core CPU, 802.11i security standard support, and high-speed data interfaces deliver the performance for the speed, reliability, and quality requirements of next generation products. Tx power calibration data, Wi-Fi, and Bluetooth system parameters are pre-stored on the one-time-programmable memory of the PAN9028 during production at Panasonic. This simplifies passing the certification process for PAN9028 customers. Furthermore, the module reduces design, test, and calibration effort resulting in reduced time-to-market compared to discrete solutions.

Integrating Wi-Fi and Bluetooth wireless connectivity allows high throughput applications for industrial devices and appliances. The combination of Wi-Fi and Bluetooth provides the highest flexibility for connectivity.

For related documents please refer to [⇒ 7.2.2 Product Information](#).

For further information on the variants and versions please refer to [⇒ 7.1 Ordering Information](#).

2.1 Block Diagram

For Module Variant ENWF940[x]A1EF

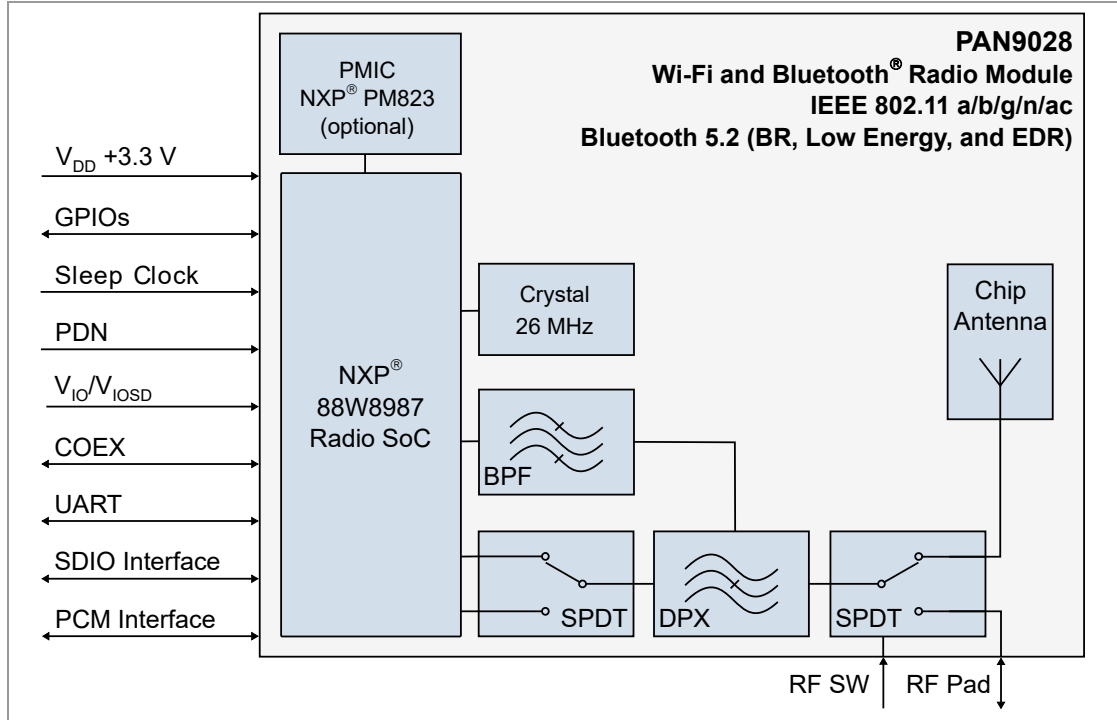

For Module Variant ENWF940[x]A2EF

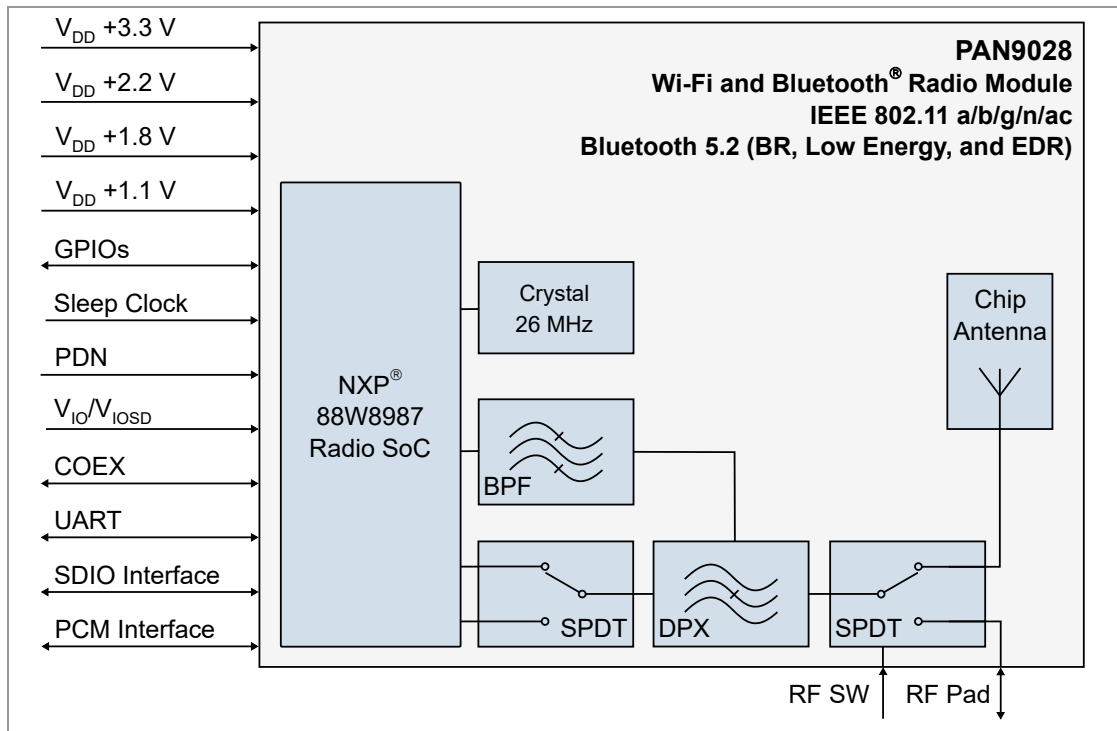

2.2 Pin Configuration

Top View

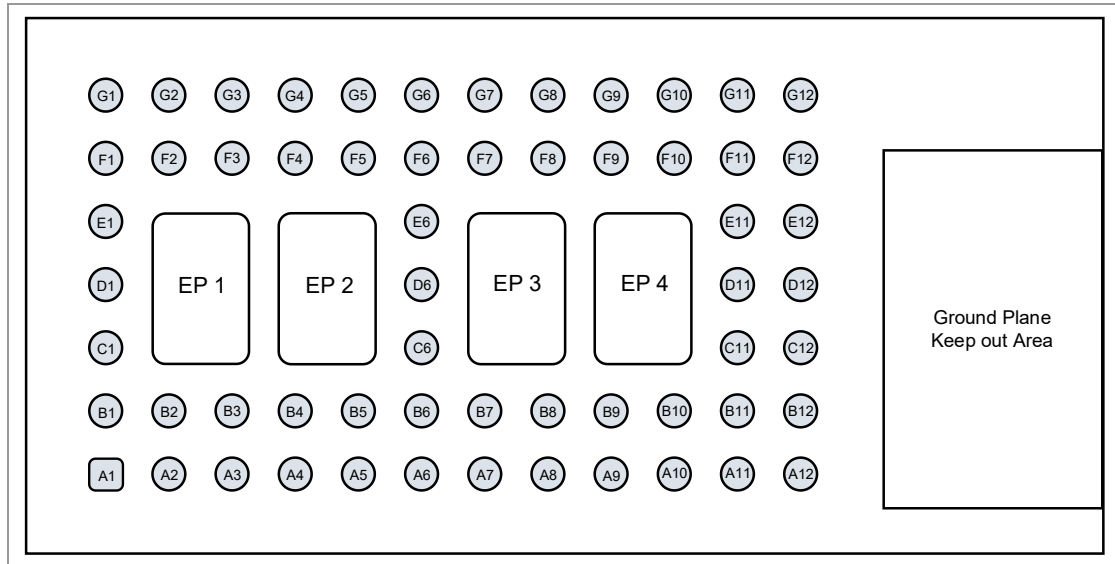

Pin Functions for Module Variant ENWF940[x]A1EF

No.	Pin Name	Pin Type	Description
A1	GND	Ground pin	Connect to ground
A2	PMIC_EN	Input signal	Power down of the PMIC/module, active-low
A3	V _{OUT1V1}	Power / NC	DNC (Do not connect) +1.1 V power supply output, only for internal supply
A4	IO14 ³	Digital I/O	General Purpose I/O – GPIO [14]
A5	DNC	NC	Do not connect
A6 ¹	UART_CTS ²	Input signal	Clear-to-send input from peripheral device
	IO10 ³	Digital I/O	General Purpose I/O – GPIO [10]
A7 ¹	UART_RTS	Output signal	Request-to-send output to peripheral device
	IO11 ³	Digital I/O	General Purpose I/O – GPIO [11]
A8 ¹	UART_SIN	Input signal	Serial data input to peripheral device
	IO9 ³	Digital I/O	General Purpose I/O – GPIO [9]

¹ Multi-purpose pins: After the firmware download, the pins (GPIO, Serial Interface, RF control) are programmed in functional mode with dedicated functionality.

² UART mode: After the dedicated firmware download, the pin is used as Host Controller Interface (HCI) for Bluetooth.

³ GPIO Mode: After the dedicated firmware download, the pin is used as Multi-Purpose Interface.

No.	Pin Name	Pin Type	Description
A9	DNC	NC	Do not connect
A10	IO20 ³	Digital I/O	General Purpose I/O – GPIO [20]
		Output signal	PAN9028 Bluetooth to host wake-up (out-of-band wake-up signal)
A11	RF_SW2	Input signal	RF Switch Pin 2 – logical voltage level to activate on-board antenna or RF Pad ⇒ RF-Switch Pin Function
A12	GND	Ground pin	Connect to ground
B1	PG1	Output signal	+1.1 V Power Good Output (float when not used) ⇒ 4.9 Power Good
B2	IO1 ³	Digital I/O	General Purpose I/O – GPIO [1]
		Output signal	PAN9028 Wi-Fi to host wake-up (out-of-band wake-up signal)
B3	32KHZ_EN	Input signal	If external 32.768 kHz crystal oscillator for LP modes is used, disable internal 32.768 kHz reference (100 Ω to GND), otherwise DNC (do not connect).
B4	IO0 ³	Digital I/O	General Purpose I/O – GPIO [0]
B5	DNC	NC	Do not connect
B6 ¹	UART_DSR	Input signal	Data set ready from peripheral device
	IO12 ³	Digital I/O	General Purpose I/O – GPIO [12]
		Input signal	Host to PAN9028 Bluetooth wake-up (out-of-band wake-up signal)
B7 ¹	UART_DTR	Output signal	Data terminal ready to peripheral device
	IO13 ³	Digital I/O	General Purpose I/O – GPIO [13]
		Input signal	Host to PAN9028 Wi-Fi wake-up (out-of-band wake-up signal)
B8 ^{1,4}	UART_SOUT	Output signal	Serial data output to peripheral device
	IO8 ³	Digital I/O	General Purpose I/O – GPIO [8]
B9	IO15 ³	Digital I/O	General Purpose I/O – GPIO [15]
B10 ¹	COEX_OUT	Output signal	Serial data output to MWS modem or peripheral device
	IO17 ³	Digital I/O	General Purpose I/O – GPIO [17]
B11	RF_SW1	Input signal	RF Switch Pin 1 – logical voltage level to activate on-board antenna or RF Pad ⇒ RF-Switch Pin Function
B12	GND	Ground pin	Connect to ground
C1	PGLDO	Output signal	+1.8 V Power Good Output (float when not used) ⇒ 4.9 Power Good
C6	CNTL2	Input signal	Connect this pin (with 50 kΩ to 100 kΩ) to GND
C11	GND	Ground pin	Connect to ground

⁴ Keep this pin open or on logical high level until firmware initialization or reset is finished. The definition of this pin changes immediately after firmware initialization or reset to its usual function.

No.	Pin Name	Pin Type	Description
C12	GND	Ground pin	Connect to ground
D1	PG2	Output signal	+2.2 V Power Good Output (float when not used) ⇒ 4.9 Power Good
D6	CNTL0	Input signal	Keep open (DNC) if using SDIO interface for Bluetooth or connect with 100 kΩ to GND if using UART interface for Bluetooth ⇒ Control Pin Function .
D11	GND	Ground pin	Connect to ground
D12	GND	Ground pin	Connect to ground
E1 ¹	PCM_CLK	Input/Output	PCM clock signal, output if PCM master, input if PCM slave
	IO6 ³	Digital I/O	General Purpose I/O – GPIO [6]
E6	SLEEP_CLOCK_IN	Input signal	Input for external 32.768 kHz crystal oscillator for LP modes if internal reference is disabled (see B3). DNC (do not connect if not used).
E11	GND	Ground pin	Connect to ground
E12	GND	Ground pin	Connect to ground
F1	GND	Ground pin	Connect to ground
F2	V _{DD3V3}	Power	+3.3 V power supply connection
F3	V _{DD3V3}	Power	+3.3 V power supply connection
F4	V _{IO5D}	Power	+1.8 V or +3.3 V Digital I/O SDIO power supply
F5 ¹	COEX_SIN	Input signal	Serial data input from MWS modem or peripheral device
	IO16 ³	Digital I/O	General Purpose I/O – GPIO[16]
F6 ¹	PCM_SYNC	Input/Output	PCM Synchronization Pulse signal, output if PCM master, input if PCM slave
	IO7 ³	Digital I/O	General Purpose I/O – GPIO [7]
F7 ¹	PCM_DOUT	Output signal	PCM data output signal
	IO5 ³	Digital I/O	General Purpose I/O – GPIO [5]
F8 ¹	LED_WLAN ⁵	Output pin	WLAN activity LED control
	IO2 ³	Digital I/O	General Purpose I/O – GPIO [2]
F9 ¹	LED_BT ⁵	Output pin	Bluetooth activity LED control
	IO3 ³	Digital I/O	General Purpose I/O – GPIO [3]
F10 ¹	PCM_DIN	Input signal	PCM data input signal
	IO4 ³	Digital I/O	General Purpose I/O – GPIO [4]
F11	GND	Ground pin	Connect to ground
F12	GND	Ground pin	Connect to ground

⁵ This feature is not supported on any NXP driver package and currently not part of FP91 (MCUXpresso SDK) and FP92 (Yocto BSP). For further information please contact us ⇒ [7.2.1 Contact Us](#).

No.	Pin Name	Pin Type	Description
G1	V _{OUT2V2}	Power	DNC (Do not connect) +2.2 V power supply output, only for internal supply
G2	V _{OUT2V2}	Power	DNC (Do not connect) +2.2 V power supply output, only for internal supply
G3	V _{IO}	Power	+1.8 V or +3.3 V power supply for General Purpose I/O and UART
G4	V _{OUT1V8}	Power	DNC (Do not connect) if not used for V _{IO} / V _{IO_{SD}} +1.8 V power supply output, only for internal supply
G5	SD_CLK	Digital I/O	For SDIO specific terminals please refer to ⇒ SDIO Pin Functions .
G6	SD_CMD	Digital I/O	
G7	SD_DAT0	Digital I/O	
G8	SD_DAT1	Digital I/O	
G9	SD_DAT2	Digital I/O	
G10	SD_DAT3	Digital I/O	
G11	GND	Ground pin	Connect to ground
G12	RF_OUT	RF port	50 Ω bottom pad to be activated by RF_SW1/RF_SW2 control voltage ⇒ RF-Switch Pin Function
EP1	EPAD1	Thermal pin	Connect to ground
EP2	EPAD2	Thermal pin	Connect to ground
EP3	EPAD3	Thermal pin	Connect to ground
EP4	EPAD4	Thermal pin	Connect to ground



The V_{OUT1V1}, V_{OUT1V8} and V_{OUT2V2} power supply pins are only for internal purpose. Do not use them to power external circuits.

Pin Functions for Module Variant ENWF940[x]A2EF

No.	Pin Name	Pin Type	Description
A1	GND	Ground pin	Connect to ground
A2	DNC	NC	Do not connect
A3	V _{DD1V1}	Power	+1.1 V power supply connection
A4	IO14 ³	Digital I/O	General Purpose I/O – GPIO [14]
A5	DNC	NC	Do not connect
A6 ¹	UART_CTS ²	Input signal	Clear-to-send input from peripheral device
	IO10 ³	Digital I/O	General Purpose I/O – GPIO [10]

No.	Pin Name	Pin Type	Description
A7 ¹	UART_RTS	Output signal	Request-to-send output to peripheral device
	IO11 ³	Digital I/O	General Purpose I/O – GPIO [11]
A8 ¹	UART_SIN	Input signal	Serial data input to peripheral device
	IO9 ³	Digital I/O	General Purpose I/O – GPIO [9]
A9	DNC	NC	Do not connect
A10	IO20 ³	Digital I/O	General Purpose I/O – GPIO [20]
		Output signal	PAN9028 Bluetooth to host wake-up (out-of-band wake-up signal)
A11	RF_SW2	Input signal	RF Switch Pin 2 – logical voltage level to activate on-board antenna or RF Pad ⇒ RF-Switch Pin Function
A12	GND	Ground pin	Connect to ground
B1	DNC	NC	Do not connect
B2	IO1 ³	Digital I/O	General Purpose I/O – GPIO [1]
		Output signal	PAN9028 Wi-Fi to host wake-up (out-of-band wake-up signal)
B3	32KHZ_EN	Input signal	If external 32.768 kHz crystal oscillator for LP modes is used, disable internal 32.768 kHz reference (100 Ω to GND), otherwise DNC (do not connect).
B4	IO0 ³	Digital I/O	General Purpose I/O – GPIO [0]
B5	PDn	Input signal	Power Down. Low active
B6 ¹	UART_DSR	Input signal	Data set ready from peripheral device
	IO12 ³	Digital I/O	General Purpose I/O – GPIO [12]
		Input signal	Host to PAN9028 Bluetooth wake-up (out-of-band wake-up signal)
B7 ¹	UART_DTR	Output signal	Data terminal ready to peripheral device
	IO13 ³	Digital I/O	General Purpose I/O – GPIO [13]
		Input signal	Host to PAN9028 Wi-Fi wake-up (out-of-band wake-up signal)
B8 ^{1,4}	UART_SOUT	Output signal	Serial data output to peripheral device
	IO8 ³	Digital I/O	General Purpose I/O – GPIO [8]
B9 ¹	IO15 ³	Digital I/O	General Purpose I/O – GPIO [15]
B10 ¹	COEX_OUT	Output signal	Serial data output to MWS modem or peripheral device
	IO17 ³	Digital I/O	General Purpose I/O – GPIO [17]
B11	RF_SW1	Input signal	RF Switch Pin 1 – logical voltage level to activate on-board antenna or RF Pad ⇒ RF-Switch Pin Function
B12	GND	Ground pin	Connect to ground
C1	DNC	NC	Do not connect
C6	CNTL2	Input signal	Connect this pin (with 50 kΩ to 100 kΩ) to GND
C11	GND	Ground pin	Connect to ground

No.	Pin Name	Pin Type	Description
C12	GND	Ground pin	Connect to ground
D1	DNC	NC	Do not connect
D6	CNTL0	Input signal	Keep open (DNC) if using SDIO interface for Bluetooth or connect with 100 kΩ to GND if using UART interface for Bluetooth ⇒ Control Pin Function .
D11	GND	Ground pin	Connect to ground
D12	GND	Ground pin	Connect to ground
E1 ¹	PCM_CLK	Input/Output	PCM clock signal, output if PCM master, input if PCM slave
	IO6 ³	Digital I/O	General Purpose I/O – GPIO [6]
E6	SLEEP_CLOCK_IN	Input signal	Input for external 32.768 kHz crystal oscillator for LP modes if internal reference is disabled (see B3). DNC (do not connect if not used).
E11	GND	Ground pin	Connect to ground
E12	GND	Ground pin	Connect to ground
F1	GND	Ground pin	Connect to ground
F2	V _{DD3V3}	Power	+3.3 V power supply connection
F3	V _{DD3V3}	Power	+3.3 V power supply connection
F4	V _{IO5D}	Power	+1.8 V or +3.3 V Digital I/O SDIO power supply
F5 ¹	COEX_SIN	Input signal	Serial data input from MWS modem or peripheral device
	IO16 ³	Digital I/O	General Purpose I/O – GPIO [16]
F6 ¹	PCM_SYNC	Input/Output	PCM Synchronization Pulse signal, output if PCM master, input if PCM slave
	IO7 ³	Digital I/O	General Purpose I/O – GPIO [7]
F7 ¹	PCM_DOUT	Output signal	PCM data output signal
	IO5 ³	Digital I/O	General Purpose I/O – GPIO [5]
F8 ¹	LED_WLAN ⁶	Output pin	WLAN activity LED control
	IO2 ³	Digital I/O	General Purpose IO – GPIO [2]
F9 ¹	LED_BT ⁶	Output pin	Bluetooth activity LED control
	IO3 ³	Digital I/O	General Purpose I/O – GPIO [3]
F10 ¹	PCM_DIN	Input signal	PCM data input signal
	IO4 ³	Digital I/O	General Purpose I/O – GPIO [4]
F11	GND	Ground pin	Connect to ground
F12	GND	Ground pin	Connect to ground

⁶ This feature is not supported on any NXP driver package and currently not part of FP91 (MCUXpresso SDK) and FP92 (Yocto BSP). For further information please contact us ⇒ [7.2.1 Contact Us](#).

No.	Pin Name	Pin Type	Description
G1	V _{DD2V2}	Power	+2.2 V power supply connection
G2	V _{DD2V2}	Power	+2.2 V power supply connection
G3	V _{IO}	Power	+1.8 V or +3.3 V power supply for General Purpose I/O and UART
G4	V _{DD1V8}	Power	+1.8 V power supply connection
G5	SD_CLK	Digital I/O	For SDIO specific terminals please refer to ⇒ SDIO Pin Functions .
G6	SD_CMD	Digital I/O	
G7	SD_DAT0	Digital I/O	
G8	SD_DAT1	Digital I/O	
G9	SD_DAT2	Digital I/O	
G10	SD_DAT3	Digital I/O	
G11	GND	Ground pin	Connect to ground
G12	RF_OUT	RF port	50 Ω bottom pad to be activated by RF_SW1/RF_SW2 control voltage ⇒ RF-Switch Pin Function
EP1	EPAD1	Thermal pin	Connect to ground
EP2	EPAD2	Thermal pin	Connect to ground
EP3	EPAD3	Thermal pin	Connect to ground
EP4	EPAD4	Thermal pin	Connect to ground

SDIO Pin Functions for all Module Variants

No.	Pin Name	Pin Type	Description	
			4-Bit Mode	1-Bit Mode
G5	SD_CLK	Digital I/O	Clock	Clock
G6	SD_CMD	Digital I/O	Command Line	Command Line
G7	SD_DAT0	Digital I/O	Data Line bit [0]	Data Line
G8	SD_DAT1	Digital I/O	Data Line bit [1] or Interrupt (optional)	Interrupt
G9	SD_DAT2	Digital I/O	Data Line bit [2] or Read Wait (optional)	Read Wait (optional)
G10	SD_DAT3	Digital I/O	Data Line bit [3]	Not used

RF-Switch Pin Functions for all Module Variants

No.	Pin Name	Pin Type	Logical Level for Activation	
			On-Board Chip Antenna	RF OUT Pin
B11	RF_SW1	Input signal	GND (0 V)	3 V to 3.6 V (typ. 3.3 V)
A11	RF_SW2	Input signal	3 V to 3.6 V (typ. 3.3 V)	GND (0 V)

Control Pin Function for all Module Variants

The control pin is used as configuration input to set parameters following a reset. The definition of the pin changes immediately after a reset to its usual function. To set a configuration bit to “0”, attach a 50 kΩ to 100 kΩ resistor from the pin to ground. No external circuitry is required to set a configuration bit to “1”.



The configuration of the control pin is used for the firmware boot option. The software reads and boots accordingly.

No.	Pin Name	Pin Type	Strap Value	WLAN	Bluetooth/ Bluetooth LE	Firmware Download		Number SDIO Functions
						Type	Mode	
D6	CNTL0	Input Signal	0	SDIO	UART	SDIO+UART	Parallel/Serial	1 (WLAN)
			1 (deprecated) ⁷	SDIO	SDIO	SDIO+SDIO	Parallel/Serial	2 (WLAN, Bluetooth)

⁷ This option is no longer supported by the current firmware and driver releases.

2.3 Host Interface

The bus interface connects several host interface bus units to the CPU bus of the device through the internal bus. The connection of each unit is multiplexed with other bus units.

The high-speed UART interface is connected to the CPU bus through a separate bus.

Type	Features
High-speed UART interface	<p>The device supports a high-speed Universal Asynchronous Receiver/Transmitter (UART) interface, compliant with the industry standard 16550 specification.</p> <ul style="list-style-type: none"> • FIFO mode permanently selected for transmit and receive operations • Two pins for transmit and receive operations • Two flow control pins • Interrupt triggers for low-power, high throughput operation
SDIO interface	<p>The device supports an SDIO device interface that conforms to the industry standard SDIO full-speed card specification and allows a host controller using the SDIO bus protocol to access the device.</p> <ul style="list-style-type: none"> • Supports SDIO 3.0 Standard • 1-bit SDIO or 4-bit SDIO transfer modes with full clock range up to 208 MHz • On-chip memory used for CIS • Special interrupt register for information exchange • Allows card to interrupt host

For further information please refer to [⇒ 4.10.1 Host Interface](#).

2.4 Peripheral Bus Interfaces

The Peripheral Bus Unit (PBU) connects several low-speed peripherals to the internal bus of the device. The device consists of the GPIO Interface and the One Time Programmable Memory (OTP).

Type	Features
General Purpose I/O (GPIO) Interface	<ul style="list-style-type: none"> • User-defined GPIOs (each configured to either input or output) • Each GPIO controlled independently • Each I/O configurable to output bit from GPIO_OUT
One Time Programmable Memory (OTP)	<ul style="list-style-type: none"> • Storing device-specific calibration data and hardware information like MAC/BD address, WLAN, and Bluetooth parameters • Programmed during production process of device • Device performs calibration when it is powered up

For further information please refer to [⇒ 4.10.2 Peripheral Interface](#).

2.5 PCM Interfaces

The device supports the PCM interface.

Type	Features
PCM Interface	<ul style="list-style-type: none"> • Master or slave mode • PCM bit width size of 8 bits or 16 bits • Up to four slots with configurable bit width and start positions • Short frame and long frame synchronization

For further information please refer to [⇒ 4.10.3 Audio Interface](#).

2.6 Coexistence

The implemented coexistence framework is based on the IEEE 802.15.2 recommended practice Packet Traffic Arbitration (PTA) scheme and the Bluetooth Special Interest Group (Bluetooth) Core Specification Volume 7 (Wireless Coexistence Volume).

2.6.1 WLAN and Bluetooth Channel Information Exchange

Since Bluetooth and IEEE 802.11b/g/n WLAN use the same 2.4 GHz frequency band, each can cause interference with the other. The level of interference depends on the respective frequency channel used by Bluetooth and WLAN (other factors can impact interference, like Tx power and Rx sensitivity of the device).

In a system with both Bluetooth and WLAN, the common host receives information about WLAN channel usage and passes the information to the Bluetooth device. For Bluetooth 1.2 devices with Adaptive Frequency Hopping (AFH) enabled, the Bluetooth device can block channel usage that overlaps the WLAN channel in use.

When the Bluetooth device avoids all channels used by the WLAN, the impact of interference is reduced, but not completely eliminated. For Bluetooth 1.1 devices, the Bluetooth device cannot block WLAN channel usage. In this case, a Bluetooth Coexistence Arbiter (BCA) scheme at MAC level is required. The BCA scheme can also be used with Bluetooth 1.2 devices to further reduce the impact of interference to a minimum.

2.6.2 External Mobile Wireless System (LTE or ZigBee) and BCA Exchange

Based on the Bluetooth SIG Wireless Coexistence Volume, the device supports a Wireless Coexistence Interface 2 (WCI-2) protocol for WLAN/Bluetooth coexistence with an external Mobile Wireless System (MWS), such as a Long Term Evolution (LTE) or ZigBee device.

WCI-2 is a 2-wire transport interface. An internal coexistence is used to exchange request/grant with the BCA.

2.6.3 System Configuration

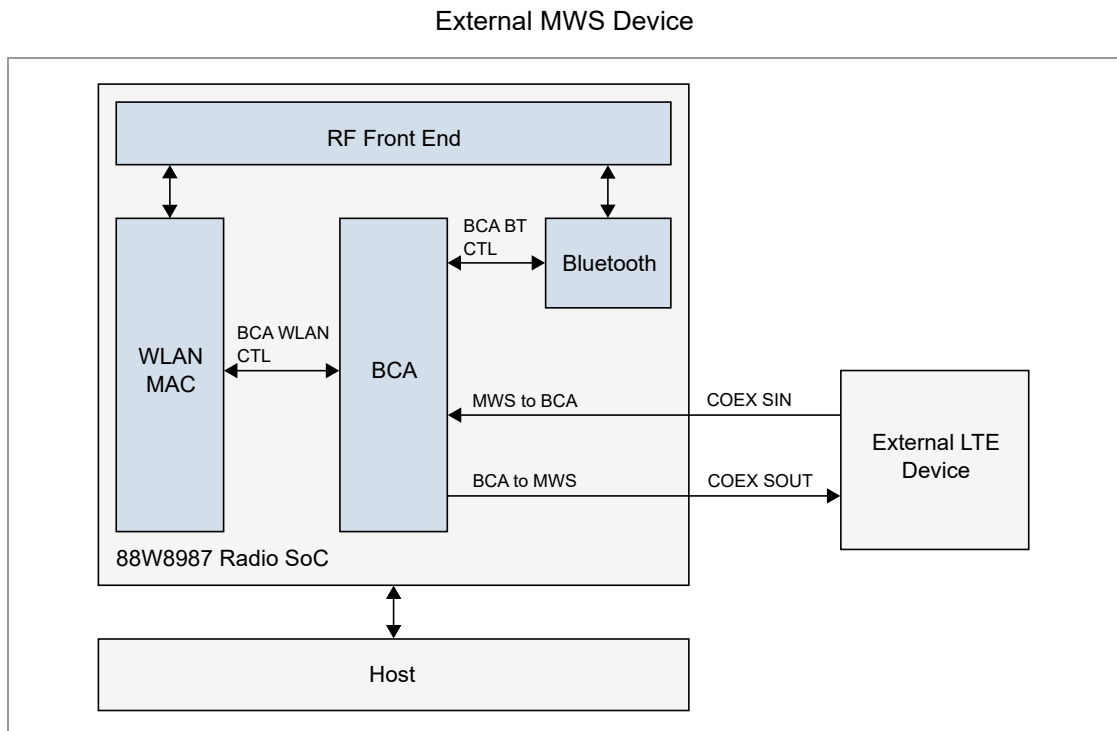

2.6.4 WCI-2 Interface

The coexistence interface includes a Mobile Wireless System (MWS) transport controller to accommodate a 2-wire, UART-based serial transport interface. This interface is a standard full-duplex UART (TxD and RxD) carrying logical signals framed as UART characters. In addition, it allows support of multiple logical channels.

Interface Signals

Pin No.	Signal Name	Specification Name	Pin Type	Description
F5	COEX_SIN	RxD	Input	Serial data from external MWS device
B10	COEX_SOUT	TxD	Output	Serial data to external MWS device

Signal Waveform Format

The messaging is based on a standard UART format. The UART signals should be connected like a null-modem. For example, the local Tx/D connected to the remote Rx/D and vice versa.

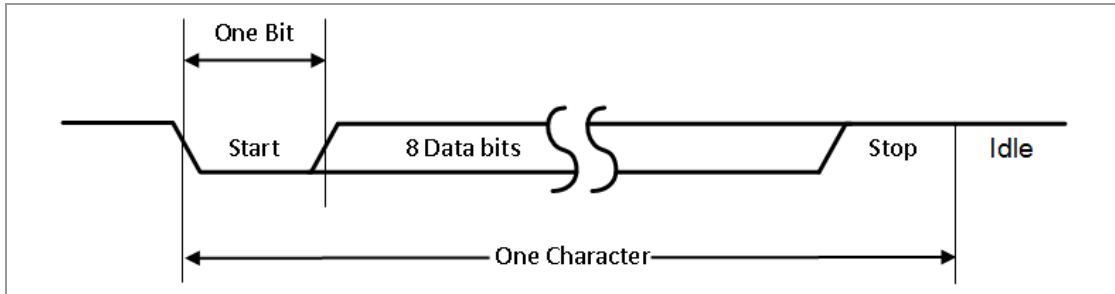

Interface Transport Settings

Item	Range	Comment
Baudrate	921 600 ~ 4 000 000	Baud
Data Bits	8	LSB first
Parity Bits	0	No parity
Stop Bit	1	One stop bit
Flow Control	No	No flow control

Support Baud Rates

Baud			
921 600	2 000 000	3 000 000	4 000 000

Real-Time Signaling Message

The real-time signaling message is used to transport real-time signals over the 2-wire transport interface.

The real-time signaling message conveys the real-time signals (Bluetooth Core Specification, Volume 7, Part A) in one message. The time reference point for the real-time signaling message is the end of message bit 5 (transition to stop bit).

Defined real-time signaling messages include:

- Coexistence Controller to MWS device
- MWS device to Coexistence Controller

Real-Time Signaling	MSG [0]	MSG [1]	MSG [2]	MSG [3]	MSG [4]
MWS to Coexistence Controller (Signal)	FRAME_SYNC	MWS_RX	MWS_TX	PATTERN [0]	PATTERN [1]
Coexistence Controller to MWS (Message)	BLUETOOTH_RX_PRI	BLUETOOTH_TX_ON	802_RX_PRI	802_TX_ON	RFU

Signal Name
FRAME_SYNC
MWS_RX
MWS_TX
PATTERN [1, 0]
BT_RX_PRI
BT_TX_ON
802_RX_PRI
802_TX_ON
MWS_INACTIVITY_DURATION
MWS_SCAN_FREQUENCY_OFFSET

Transport Control Message

The transport control messages can modify the state and request state information of the MWS coexistence interface.

Message	MSG [0]	MSG [1]	MSG [2]	MSG [3]	MSG [4]
Transport Control Message	RESEND_REAL_TIME	RFU	RFU	RFU	RFU

Signal Name	Description
RESEND_REAL_TIME	<p>This bit is set if a device wants to get a status update of the real-time signals. The signal is usually used after wake-up from sleep of the transport interface to get an update of the real-time signals.</p> <p>If the receiving device's transport interface is awake it shall send a real-time message with the current status of the real-time signals within 4 UART character period. If the signal is not transmitted within 4 UART character periods, the device is considered asleep.</p> <p>If the receiving device's transport interface is not awake it shall not send a real-time message.</p> <p>Bluetooth initiated: If the MWS is currently scanning or has an ongoing inactivity duration, the MWS shall send a frequency scan message or an inactivity duration message after transmitting the real-time message. If the receiving device's transport interface is not awake it shall not send a frequency scan or inactivity duration message.</p>

Transparent Data Message

The transparent control messages can modify the state and request state information of the MWS coexistence interface.

Message	MSG [0]	MSG [1]	MSG [2]	MSG [3]	MSG [4]
Transparent Data Message	NIBBLE_POSITION	DATA [0]/[4]	DATA [1]/[5]	DATA [2]/[6]	DATA [3]/[7]

Signal Name	Description
NIBBLE_POSITION	0 = least significant nibble 1 = most significant nibble
DATA[n]; n=0 .. 7	Data bits of the message octet

MWS Inactivity Duration Message

The inactivity duration messages is used to send the MWS_INACTIVITY_DURATION signal from the MWS device to the Coexistence Controller.

Message	MSG [0]	MSG [1]	MSG [2]	MSG [3]	MSG [4]
MWS Inactivity Duration Message	DURATION [0]	DURATION [1]	DURATION [2]	DURATION [3]	DURATION [4]

The idle duration is encoded in 5 bits given by the formula:

$$\text{Inactivity_Duration} = \text{DURATION} \cdot 5 \text{ ms}$$

Inactivity durations smaller than 5 ms are not communicated.

If all bits are set to "1" the inactivity duration is infinite. If all bits are set to "0" or MWS_RX or MWS_TX are set to "1", the inactivity period ends.

MWS Scan Frequency Offset Message

The MWS scan frequency offset message is used to send the MWS_SCAN_FREQUENCY_OFFSET signal from the MWS device to the Coexistence Controller.

Message	MSG [0]	MSG [1]	MSG [2]	MSG [3]	MSG [4]
MWS Scan Frequency Offset	BAND	FREQ [0]	FREQ [1]	FREQ [2]	FREQ [3]

The RF scan frequency is encoded in 5 bits given by the formula:

$$\text{RF_FREQ_OFFSET} = \text{FREQ} \cdot 10 \text{ MHz}$$

If BAND is set to “0” the RF_FREQ_OFFSET is the negative value from the lower edge of the ISM band. If BAND is set to “1”, RF_FREQ_OFFSET is the positive value from the top edge of the ISM band.

FREQ set to all “0” indicates the end of the scan period.

2.6.5 Bluetooth Coexistence Arbiter

Type	Features
Capability	<ul style="list-style-type: none"> • Programmable coexistence interface timing, interface modes, and signal polarity to support a variety of external Bluetooth devices • Programmable decision policies and transaction lock behavior for various use cases • Interface with external or on-chip Bluetooth device • Support Bluetooth 1.1 or Bluetooth 1.2 AFH • WLAN-/Bluetooth-coordinated low-power design • Enhanced information sharing between WLAN and Bluetooth for combo systems • WLAN/Bluetooth/MWS (LTE or ZigBee) coexistence support
Arbitration	<ul style="list-style-type: none"> • Contention resolved by a customizable decision matrix that allows independent grant decision for each device • Vectors for the decision matrix: <ul style="list-style-type: none"> – WLAN priority (2-bit) – WLAN direction – Bluetooth priority (1-bit or 2-bit) – Bluetooth direction – Bluetooth frequency in/out band – MWS priority (2-bit) – MWS direction
AFH	<p>If AFH is enabled in the Bluetooth device, and there is a sufficient guard-band outside the WLAN operating frequency, the Bluetooth device uses the Out-Of-Band (OOB) channel with respect to the WLAN device. Otherwise, the Bluetooth device uses the In-Band (IB) and OOB channels with respect to the WLAN device.</p> <p>The IB and OOB information is either provided by the Bluetooth device through the coexistence interface, or it can be provided through firmware controls in a shared-host system. IB/OOB is a vector in the decision matrix.</p>
Decision Policies	<p>System configuration is a major consideration when planning decision policies. The configuration governs how RF paths are shared and how much interference will occur.</p> <p>Interference combinations include:</p> <ul style="list-style-type: none"> – WLAN Tx and Bluetooth Tx – WLAN Tx and Bluetooth Rx – WLAN Rx and Bluetooth Tx – WLAN Rx and Bluetooth Rx

Type	Features
	<p>Interference combinations where WLAN and Bluetooth share the same antenna:</p> <ul style="list-style-type: none"> – WLAN Tx and Bluetooth Tx share same antenna, the decision matrix allows either WLAN or Bluetooth Tx (both OOB and IB), based on relative packet priorities. – WLAN Tx and Bluetooth Rx (both OOB and IB) have sizable interference impacts on Bluetooth Rx, the decision matrix grants or denies WLAN Tx based on relative packet priorities. – WLAN Rx and Bluetooth Tx (both OOB and IB) have sizable interference impacts on WLAN Rx, the decision matrix grants or denies Bluetooth Tx based on relative packet priorities. – WLAN Rx and Bluetooth Rx (both OOB and IB) have no impact on each other, the decision matrix grants both. <p>Interference combinations where WLAN and Bluetooth have their own antenna:</p> <ul style="list-style-type: none"> – WLAN Tx and Bluetooth Tx in OOB situation have little interference impact on each other, the decision matrix grants both. – WLAN Tx and Bluetooth Tx in IB have sizable interference impact on each other, the decision matrix allows either WLAN or Bluetooth Tx, based on relative packet priorities. – WLAN Tx and Bluetooth Rx in OOB situation have little interference impact on each other, the decision matrix grants both provided there is enough antenna isolation between WLAN and Bluetooth antenna. – WLAN Tx and Bluetooth Rx in IB situation have sizable interference impact on Bluetooth Rx, the decision matrix grants or denies WLAN Tx based on relative packet priorities. – WLAN Rx and Bluetooth Tx in OOB situation have little interference impact on each other, the decision matrix grants both provided there is enough antenna isolation between WLAN and Bluetooth antenna. – WLAN Rx and Bluetooth Tx in IB situation have sizable interference impact on WLAN RX, the decision matrix grants or denies Bluetooth Tx based on relative packet priorities. – WLAN Rx and Bluetooth Rx (both OOB and IB) have no impact on each other, the decision matrix grants both.
Decision Policies (continued)	<p>For the devices running in a basic shared antenna configuration, the linear switching imposes restrictions on simultaneous transfer. Reasonable policies include:</p> <ul style="list-style-type: none"> – WLAN and Bluetooth are never granted at the same time – Decision matrix grants a device based on relative packet priorities and direction – Priority order: High > Medium High > Medium > Low – For equal priority contention, select one device to win, that optimizes the usage case <p>For the devices running in an enhanced shared antenna configuration, the linear switching imposes restrictions on some simultaneous transfers.</p>
Transaction Stopping	<p>The arbiter allows control of what transfers can be stopped after an initial grant. If allowed, a transaction can be stopped for higher priority request. A transaction stop decision is a function of the decision policies and transaction stopping control. The transaction stopping control is configurable per device and direction.</p>

2.6.6 Bluetooth Capability

Type	Features
Request Schemes	<p>The PTA signals are directly controlled by the hardware to meet timing requirements of the Bluetooth radio. The software controls the type of traffic in priority mode.</p> <p>Mechanisms enforced for control include:</p> <ul style="list-style-type: none"> • Selection of certain types of communication always treated as high priority • Selection of individual frames marked with high priority • Real-time signaling of the next slot marked with high priority • Automatic hardware control based on the grant/denial history of the Bluetooth link
Timing Control	<p>The PTA signal timing scheme is fully programmable relative to the Bluetooth packet timing.</p>

2.6.7 WLAN Capability

Type	Features
Capability	<p>The WLAN device technology uses an internal coexistence interface to exchange request/grant with the BCA.</p> <p>Features:</p> <ul style="list-style-type: none"> • Packet-based request signaling with direction and priority information • 1-bit or 2-bit priority signaling to support 4 priority levels • Multiple WLAN Rx request trigger sources, including early prediction • WLAN Tx request cancellation and abort if grant denied or revoked in middle of request • 802.11n A-MPDU treated as single packet
Packet Classification	<ul style="list-style-type: none"> • Programmable mask allows each frame type to be mapped to a priority • Default setting puts response frames (ACK), beacons, and QoS frames as high priority • WLAN Tx and Rx have separate priority masks
Queue Classification	<ul style="list-style-type: none"> • Programmable mask allows each transmit queue to be mapped to a priority • Queue-based mapping is optional for software-generated frames only

2.6.8 LTE (MWS) Capability

The device supports a Bluetooth SIG WCI-2 MWS coexistence signaling interface. The coexistence logical signaling is designed to enable a standard interface to allow an MWS device and a Coexistence Controller to exchange information and support cooperative coexistence.

The WCI-2 signals carry time-critical information such as the start point of an MWS frame. The logical coexistence signaling architecture also includes transparent data messaging and vendor specific data messaging mechanism to enable passing information to and from the collocated MWS device and Coexistence Controller when long latency (tens of milliseconds) cannot be tolerated.

For further information please refer to [⇒ 2.6.4 WCI-2 Interface](#).

Coexistence Signals

The logical signals assist in time alignment, protecting MWS from interference and maximizing the usability of the Bluetooth radio.

Time-Critical Coexistence Signals

Signal Name	Direction
FRAME_SYNC	MWS to Bluetooth
BT_RX_PRI	Bluetooth to MWS
BT_TX_ON	Bluetooth to MWS
802_RX_PRI	Bluetooth to MWS
802_TX_ON	Bluetooth to MWS
MWS_PATTERN	MWS to Bluetooth
MWS_RX	MWS to Bluetooth
MWS_TX	MWS to Bluetooth
MWS_INACTIVITY_DURATION	MWS to Bluetooth
MWS_SCAN_FREQUENCY_OFFSET	MWS to Bluetooth
MWS_TX_PRIL (MWS TX Priority Level)	MWS to Bluetooth
MWS_RX_PRIL (MWS RX Priority Level)	MWS to Bluetooth

2.6.9 ZigBee (MWS) Coexistence Capability

ZigBee is based on the IEEE 802.15.4 standard. It is used by a suite of communication protocols to create Personal Area Networks (PANs) supporting home automation, lighting control, etc. ZigBee radios operate in the 2.4 GHz ISM band worldwide. Unlike Bluetooth, the ZigBee specification does not use AFH. When coexisting with WLAN/Bluetooth in the 2.4 GHz band, it is important to avoid co-channel (IB) operation of these radios.

The device re-uses the MWS coexistence interface to support ZigBee coexistence. The coexistence logical signaling is used to allow a ZigBee device and a WLAN/Bluetooth combo device to exchange information and support cooperative coexistence.

Coexistence Signals

The logical signals used for ZigBee and WLAN/Bluetooth coexistence are a subset of the LTE coexistence signaling. Considering the lower data rate of ZigBee packets, a lower baud rate may be chosen for the 2-wire UART physical interface. The BCA supports 3-way arbitration among ZigBee/WLAN/Bluetooth requests.

Coexistence Signals

Signal Name	Direction
MWS_RX	MWS to Bluetooth
MWS_TX	MWS to Bluetooth
MWS_PATTERN	MWS to Bluetooth
MWS_RX_PRI	MWS to Bluetooth
MWS_TX_PRI	MWS to Bluetooth
802_RX_PRI	Bluetooth to MWS
802_TX_ON	Bluetooth to MWS
BT_RX_PRI	Bluetooth to MWS
BT_TX_ON	Bluetooth to MWS

2.7 WLAN

Type	Features
IEEE 802.11/ Standards	<ul style="list-style-type: none"> • 802.11 data rates 1 Mbps and 2 Mbps (DSSS) • 802.11b data rates 5.5 Mbps and 11 Mbps (CCK) • 802.11a/g data rates 6 Mbps, 9 Mbps, 12 Mbps, 18 Mbps, 24 Mbps, 36 Mbps, 48 Mbps, and 54 Mbps (OFDM) • 802.11b/g performance enhancements • 802.11n/ac with maximum data rates up to 86.7 Mbps (20 MHz channel), 200 Mbps (40 MHz channel), 433 Mbps (80 MHz channel) • 802.11d international roaming • 802.11e quality of service (QoS) • 802.11h transmit power control • 802.11h DFS radar pulse detection • 802.11i enhanced security (WEP, WPA, WPA2) • 802.11k radio resource measurement • 802.11n block acknowledgment extension • 802.11r fast hand-off for AP roaming • 802.11u Hotspot 2.0 (STA mode only) • 802.11v TIM frame transmission/reception • 802.11w protected management frames • Support clients (stations) implementing IEEE Power Save mode
WLAN MAC	<ul style="list-style-type: none"> • Frame exchange at the MAC level to deliver data • Received frame filtering and validation (CRC) • Generation of MAC header and trailer information (MPDUs) • Fragmentation of data frames (MSDUs) • Access mechanism support for fair access to shared wireless medium through: <ul style="list-style-type: none"> – Distributed Coordination Function (DCF) – Enhanced Distributed Channel Access (EDCA) • A-MPDU aggregation/de-aggregation (supports 802.11ac single-MPDU A-MPDU) • 20 MHz, 40 MHz, and 80 MHz channel coexistence • RIFS burst receive • Management information base • Radio resource measurement • Quality of service • Block acknowledgement • 802.11ac downlink MU-MIMO (receive) • Dynamic frequency selection • TIM frame Tx and Rx • Multiple BSS/Station • Transmit rate adaption • Transmit power control

Type	Features
WLAN Baseband	<ul style="list-style-type: none"> • 802.11ac 1×1 SISO (WLAN SoC with SISO RF radio) • Backward compatibility with legacy 802.11a/b/g/n technology • WLAN/Bluetooth LNA sharing • PHY data rates up to 433 Mbps • 20 MHz bandwidth/channel, 40 MHz bandwidth/channel, upper/lower 20 MHz bandwidth in 40 MHz channel, and 20 MHz duplicate legacy bandwidth in 40 MHz channel mode operation • 80 MHz bandwidth/channel, 4 positions of 20 MHz bandwidth in 80 MHz channel, upper/lower 40 MHz bandwidth in 80 MHz channel, 20 MHz quadruplicate legacy bandwidth in 80 MHz channel mode operation • Modulation and Coding Scheme <ul style="list-style-type: none"> – 802.11n: MCS 0 ~ 7 and MCS 32 (duplicate 6 Mbps) – 802.11ac: MCS 0~9 NSTS = 1 • Dynamic frequency selection (radar detection) <ul style="list-style-type: none"> – Enhanced radar detection for short and long pulse radar – Enhanced AGC scheme for DFS channel – Japan DFS requirement for W53 and W56 • 802.11k Radio resource measurement <hr/> <ul style="list-style-type: none"> • 802.11n/ac optional features: <ul style="list-style-type: none"> – 20 MHz, 40 MHz, and 80 MHz coexistence with middle-packet detection (GI detection) for enhanced CCA – Space-Time-Block-Coding (STBC) one spatial stream reception – LDPC transmission and reception for both 802.11n and 802.11ac – 256 QAM (MCS 8, 9) modulation (optional support for 802.11ac MCS 9 in 20 MHz using LDPC) – Short Guard Interval – RIFS on receive path for 802.11n packets – Explicit Beamformee support – 802.11ac multi-user beamformee – 802.11n Greenfield Tx/Rx – MU-PPDUs (receive) • Power save features
WLAN Radio	<ul style="list-style-type: none"> • Integrated direct-conversion radio • 20 MHz, 40 MHz, and 80 MHz channel bandwidth • Shared WLAN/Bluetooth receive input scheme for 2.4 GHz band • Rx Path <ul style="list-style-type: none"> – On-chip gain selectable LNA with optimized noise figure and power consumption – High dynamic range AGC function in receive mode • Tx Path <ul style="list-style-type: none"> – Internal PA with power control – Optimized Tx gain distribution for linearity and noise performance • Local Oscillator with fine channel step

Type	Features
WLAN Encryption	<ul style="list-style-type: none"> • WEP 64-bit and 128-bit encryption with hardware TKIP processing (WPA) • AES-CCMP hardware implementation as part of 802.11i security standard (WPA2) • Advanced encryption standard (AES)/Counter-Mode/CBC-MAC Protocol (CCMP) • AES-Cipher-Based Message Authentication Code (CMAC) as part of the 802.11w security standard • WLAN Authentication and Privacy Infrastructure (WAPI) • Simultaneous Authentication of Equals (SAE) with AES-CCMP-128 encryption (WPA3-Personal)

Operation Modes

Parameter	Operation Mode				Specification	
Standard Conformance	IEEE 802.11/IEEE 802.11b					
	IEEE 802.11a					
	IEEE 802.11g					
	IEEE 802.11n					
	IEEE 802.11ac					
Modulation	IEEE 802.11a				OFDM	
	IEEE 802.11b				DSSS/CCK	
	IEEE 802.11g				OFDM	
	IEEE 802.11n				OFDM at MCS0~7 and MCS32 (duplicate 6 Mbps)	
	IEEE 802.11ac				OFDM at MCS0~9	
Physical layer data rates	IEEE 802.11				1 Mbps, 2 Mbps at DSSS	
	IEEE 802.11b				5.5 Mbps, 11 Mbps at DSSS/CCK	
Supported data rates	IEEE 802.11g				[6, 9, 12, 18, 24, 36, 48, 54] Mbps	
	IEEE 802.11a				[6, 9, 12, 18, 24, 36, 48, 54] Mbps	
	IEEE 802.11n	MCS0~7	HT20	LGI	[6.5, 13, 19.5, 26, 39, 52, 58.5, 65] Mbps	
				SGI	[7.2, 14.4, 21.7, 28.9, 43.3, 57.8, 65, 72.2] Mbps	
				HT40	LGI	[13.5, 27, 40.5, 54, 81, 108, 121.5, 135] Mbps
				SGI	[15, 30, 45, 60, 90, 120, 135, 150] Mbps	
	IEEE 802.11ac	MCS0~8	HT20	LGI	[6.5, 13, 19.5, 26, 39, 52, 58.5, 65, 78] Mbps	
				SGI	[7.2, 14.4, 21.7, 28.9, 43.3, 57.8, 65, 72.2, 86.7] Mbps	
				HT40	LGI	[13.5, 27, 40.5, 54, 81, 108, 121.5, 135, 162, 180] Mbps
					SGI	[15, 30, 45, 60, 90, 120, 135, 150, 180, 200] Mbps
		VHT80	LGI	[29.3, 58.5, 87.8, 117, 175.5, 234, 263.3, 292.5, 351, 390] Mbps		

Parameter	Operation Mode				Specification
				SGI	[32.5, 65, 97.5, 130, 195, 260, 292.5, 325, 390, 433.3] Mbps
Supported bandwidth	IEEE 802.11n				20 MHz, 40 MHz (BW)
	IEEE 802.11ac				20 MHz, 40 MHz, 80 MHz (BW)
Supported channel mode operation	IEEE 802.11n				20 MHz BW/channel, 40 MHz BW/channel, upper/lower 20 MHz BW at 40 MHz channel, 20 MHz duplicate legacy BW at 40 MHz channel
	IEEE 802.11ac				20 MHz BW/channel, 40 MHz BW/channel, 80 MHz BW/channel, upper/lower 20 MHz BW at 40 MHz channel, 20 MHz duplicate legacy BW at 40 MHz channel, 4 positions of 20 MHz BW at 80 MHz channel, upper/lower 40 MHz BW at 80 MHz channel, 20 MHz quadruplicate legacy BW at 80 MHz channel
Supported Guard Interval	IEEE 802.11n				400 ns (SGI), 800 ns (LGI)
	IEEE 802.11ac				400 ns (SGI), 800 ns (LGI)

Channels and Frequencies (without Regulatory Restrictions)



This section shows the general capabilities of the hardware. The implemented and supported channels may differ.

Please refer to ⇒ [Channel Tables based on Regulatory Domain/Country](#) for product specific information.

2.4 GHz – IEEE 802.11b/g/n						
20 MHz Channels			40 MHz Channels			
Channel	Frequency	Unit	Channel	Frequency	Unit	
1	2 412	MHz	1 to 5	2 422	MHz	
2	2 417	MHz	2 to 6	2 427	MHz	
3	2 422	MHz	3 to 7	2 432	MHz	
4	2 427	MHz	4 to 8	2 437	MHz	
5	2 432	MHz	5 to 9	2 442	MHz	
6	2 437	MHz	6 to 10	2 447	MHz	
7	2 442	MHz	7 to 11	2 452	MHz	
8	2 447	MHz				
9	2 452	MHz				
10	2 457	MHz				
11	2 462	MHz				
12	2 467	MHz				
13	2 472	MHz				

5 GHz – IEEE 802.11a/n/ac					
20 MHz Channels			40 MHz Channels		
Channel	Frequency	Unit	Channel	Frequency	Unit
36	5 180	MHz	36 to 40	5 190	MHz
40	5 200	MHz	44 to 48	5 230	MHz
44	5 220	MHz	52 to 56	5 270	MHz
48	5 240	MHz	60 to 64	5 310	MHz
52	5 260	MHz			
56	5 280	MHz			
60	5 300	MHz			
64	5 320	MHz			
100	5 500	MHz	100 to 104	5 510	MHz
104	5 520	MHz	108 to 112	5 550	MHz
108	5 540	MHz	116 to 120	5 590	MHz
112	5 560	MHz	124 to 128	5 630	MHz
116	5 580	MHz	132 to 136	5 670	MHz
120	5 600	MHz	149 to 153	5 755	MHz
124	5 620	MHz	157 to 161	5 795	MHz
128	5 640	MHz			
132	5 660	MHz			
136	5 680	MHz			
140	5 700	MHz			
149	5 745	MHz			
153	5 765	MHz			
157	5 785	MHz			
161	5 805	MHz			
165	5 825	MHz			

5 GHz – IEEE 802.11a/n/ac					
80 MHz Channels					
Channel	Frequency	Unit	Channel	Frequency	Unit
36 to 48	5 210	MHz			
52 to 64	5 290	MHz			
100 to 112	5 530	MHz			
116 to 128	5 610	MHz			
132 to 144	5 690	MHz			

5 GHz – IEEE 802.11a/n/ac					
80 MHz Channels					
Channel	Frequency	Unit	Channel	Frequency	Unit
149 to 161	5 775	MHz			

5 GHz – IEEE 802.11a/n/ac (India and additional UNII Channels)					
20 MHz Channels			40 MHz Channels		
Channel	Frequency	Unit	Channel	Frequency	Unit
144	5 720	MHz	68 to 72	5 350	MHz
169 ⁸	5 845	MHz	76 to 80	5 390	MHz
173 ⁸	5 865	MHz	84 to 88	5 430	MHz
177	5 885	MHz	92 to 96	5 470	MHz
181	5 905	MHz	140 to 144	5 710	MHz
			165 to 169	5 835	MHz
			169 to 173 ⁹	5 855	MHz
			173 to 177	5 875	MHz

5 GHz – IEEE 802.11a/n/ac (India and additional UNII Channels)					
80 MHz Channels					
Channel	Frequency	Unit	Channel	Frequency	Unit
68 to 80	5 370	MHz			
84 to 96	5 410	MHz			
165 to 177	5 855	MHz			

⁸ India channels that can be used in other countries as well.

⁹ India use only.

Channel Tables based on Regulatory Domain/Country

2.4 GHz IEEE 802.11b/g/n/ac																				
802.11 Operation Mode																				
Data Rates																				
<div style="display: flex; justify-content: space-between;"> 11b 11g 20M 11n/ac 20M 11ac 20M 11ac 40M </div>																				
<div style="display: flex; justify-content: space-between;"> 1M – 11M 6M – 18M 24M – 36M 48M – 54M MCS0 – MCS4 MCS5 – MCS7 MCS8 MCS0 – MCS4 MCS5 – MCS7 MCS8 – MCS9 0 = disable 1 = enable Device Mode Y = Yes/N = No </div>																				
Model Variant ¹⁰	Channel 20M	Channel 40M	Lower/Upper	Frequenz	Unit	Tx Power (maximum)										Unit	DFS	Passive Scan	Master	Client
MR	1	1	L	2412	MHz	15	15	15	15	15	15	14	13	12	11	dBm	0	0	Y	Y
	2	2	L	2417	MHz	16	16	16	16	16	16	15	14	13	12	dBm	0	0	Y	Y
	3	3	L/U	2422	MHz	16	16	16	16	16	16	15	14	13	12	dBm	0	0	Y	Y
	4	4	L/U	2427	MHz	16	16	16	16	16	16	15	14	13	12	dBm	0	0	Y	Y
	5	5	L/U	2432	MHz	16	16	16	16	16	16	15	14	13	12	dBm	0	0	Y	Y
	6	6	L/U	2437	MHz	16	16	16	16	16	16	15	14	13	12	dBm	0	0	Y	Y
	7	7	L/U	2442	MHz	16	16	16	16	16	16	15	14	13	12	dBm	0	0	Y	Y
	8	8	L/U	2447	MHz	16	16	16	16	16	16	15	14	13	12	dBm	0	0	Y	Y
	9	9	L/U	2452	MHz	16	16	16	16	16	16	15	14	13	12	dBm	0	0	Y	Y
	10	10	U	2457	MHz	16	16	16	16	16	16	15	14	13	12	dBm	0	0	Y	Y
	11	11	U	2462	MHz	15	15	15	15	15	15	14	13	12	11	dBm	0	0	Y	Y
	12	-	-	2467	MHz	-	-	-	-	-	-	-	-	-	-	dBm	-	-	N	N
	13	-	-	2472	MHz	-	-	-	-	-	-	-	-	-	-	dBm	-	-	N	N
	14	-	-	2484	MHz	-	-	-	-	-	-	-	-	-	-	dBm	-	-	N	N

¹⁰ The country related module variants are using a channel table with Tx Power, DFS, and Passive Scan settings, which is pre-stored and locked in the OTP memory of the module and cannot be changed by host driver API. For information about the model variants restricted to a particular regulatory domain please refer to [7.1 Ordering Information](#).

5 GHz IEEE 802.11a/n/ac																					
802.11 Operation Mode																					
Data Rates																					
Model Variant ¹¹	Channel 20M	Channel 40M	Channel 80M	Frequenz	Unit	Tx Power (maximum)	11a		11n/ac 20M		11n/ac 40M		11ac 40M		11ac 80M		Unit	DFS	Passive Scan	Master	Client
							6M - 54M	MCS0 - MCS4	MCS5 - MCS7	MCS8	MCS0 - MCS4	MCS5 - MCS7	MCS8 - MCS9	MCS0 - MCS4	MCS5 - MCS7	MCS8 - MCS9					
MR	36	38	42	5 180	MHz	16	16	15	12	16	15	11	14	12	10	dBm	0	0	Y	Y	
	40			5 200	MHz	16	16	15	12	16	15	11	14	12	10	dBm	0	0	Y	Y	
	44	5 220		MHz	16	16	15	12	16	15	11	14	12	10	dBm	0	0	Y	Y		
	48	5 240		MHz	16	16	15	12	16	15	11	14	12	10	dBm	0	0	Y	Y		
	52	54	58	5 260	MHz	-	-	-	-	-	-	-	-	-	-	dBm	-	-	N	N	
	56			5 280	MHz	-	-	-	-	-	-	-	-	-	-	dBm	-	-	N	N	
	60	5 300		MHz	-	-	-	-	-	-	-	-	-	-	dBm	-	-	N	N		
	64	5 320		MHz	-	-	-	-	-	-	-	-	-	-	dBm	-	-	N	N		
	100	102	106	5 500	MHz	-	-	-	-	-	-	-	-	-	dBm	-	-	N	N		
	104			5 520	MHz	-	-	-	-	-	-	-	-	-	dBm	-	-	N	N		
	108	5 540		MHz	-	-	-	-	-	-	-	-	-	-	dBm	-	-	N	N		
	112	5 560		MHz	-	-	-	-	-	-	-	-	-	-	dBm	-	-	N	N		
	116	118	122	5 580	MHz	-	-	-	-	-	-	-	-	-	dBm	-	-	N	N		
	120			5 600	MHz	-	-	-	-	-	-	-	-	-	dBm	-	-	N	N		
	124	5 620		MHz	-	-	-	-	-	-	-	-	-	-	dBm	-	-	N	N		
	128	5 640		MHz	-	-	-	-	-	-	-	-	-	-	dBm	-	-	N	N		
	132	134	138	5 660	MHz	-	-	-	-	-	-	-	-	-	dBm	-	-	N	N		
	136			5 680	MHz	-	-	-	-	-	-	-	-	-	dBm	-	-	N	N		
	140	5 700		MHz	-	-	-	-	-	-	-	-	-	-	dBm	-	-	N	N		
	144	5 720		MHz	-	-	-	-	-	-	-	-	-	-	dBm	-	-	N	N		
149	151	155	5 745	MHz	10	10	10	10	10	10	10	10	10	dBm	0	0	Y	Y			
153			5 765	MHz	10	10	10	10	10	10	10	10	10	dBm	0	0	Y	Y			
157	159		5 785	MHz	10	10	10	10	10	10	10	10	10	dBm	0	0	Y	Y			

¹¹ The country related module variants are using a channel table with Tx Power, DFS, and Passive Scan settings, which is pre-stored and locked in the OTP memory of the module and cannot be changed by host driver API. For information about the model variants restricted to a particular regulatory domain please refer to [7.1 Ordering Information](#).

5 GHz IEEE 802.11a/n/ac																																																			
802.11 Operation Mode																																																			
Data Rates																																																			
<table border="1"> <tr> <td></td> <td></td> <td></td> <td></td> <td></td> <td>11a</td> <td>11n/ac</td> <td>20M</td> <td>11ac 20M</td> <td>11n/ac</td> <td>40M</td> <td>11ac 40M</td> <td>11ac</td> <td>80M</td> <td></td> <td></td> <td></td> </tr> <tr> <td></td> <td></td> <td></td> <td></td> <td></td> <td>6M - 54M</td> <td>MCS0 - MCS4</td> <td>MCS5 - MCS7</td> <td>MCS8</td> <td>MCS0 - MCS4</td> <td>MCS5 - MCS7</td> <td>MCS8 - MCS9</td> <td>MCS0 - MCS4</td> <td>MCS5 - MCS7</td> <td>MCS8 - MCS9</td> <td></td> <td></td> <td></td> </tr> </table>																						11a	11n/ac	20M	11ac 20M	11n/ac	40M	11ac 40M	11ac	80M									6M - 54M	MCS0 - MCS4	MCS5 - MCS7	MCS8	MCS0 - MCS4	MCS5 - MCS7	MCS8 - MCS9	MCS0 - MCS4	MCS5 - MCS7	MCS8 - MCS9			
					11a	11n/ac	20M	11ac 20M	11n/ac	40M	11ac 40M	11ac	80M																																						
					6M - 54M	MCS0 - MCS4	MCS5 - MCS7	MCS8	MCS0 - MCS4	MCS5 - MCS7	MCS8 - MCS9	MCS0 - MCS4	MCS5 - MCS7	MCS8 - MCS9																																					
Model Variant ¹¹	Channel 20M	Channel 40M	Channel 80M	Frequenz	Unit	Tx Power (maximum)								Unit	DFS	Passive Scan	Master	Client																																	
161				5 805	MHz	10	10	10	10	10	10	10	10	dBm	0	0	Y	Y																																	
165	-	-	-	5 825	MHz	10	10	10	10	-	-	-	-	dBm	0	0	Y	Y																																	

2.8 Bluetooth

Type	Features
General	<ul style="list-style-type: none"> • Supports Bluetooth 5.2 • Shared LNA for Bluetooth • Digital Audio Interface including PCM interface for voice application • Bluetooth and WLAN coexistence
Bluetooth Classic (BR/EDR)	<ul style="list-style-type: none"> • Bluetooth Classic with Bluetooth Class 1 support • Baseband and radio Basic Rate (BR) and Enhanced Data Rate (EDR) packet types with 1 Mbps (GFSK), 2 Mbps ($\pi/4$-DQPSK) and 3 Mbps (8DPSK) • Fully functional Bluetooth baseband with: <ul style="list-style-type: none"> - Adaptive Frequency Hopping (AFH) - Forward error correction - Header error control - Access code correlation - CRC - Encryption bit stream generation - Whitening • Adaptive Frequency Hopping (AFH) including Packet Loss Rate (PLR) • Interlaced scan for faster connection setup • Simultaneous 7 active ACL connection support • Automatic ACL packet type selection • Full master and slave piconet support

Type	Features
	<ul style="list-style-type: none"> • Scatternet support • Standard UART and SDIO HCI transport layer • 3 SCO/eSCO links with hardware accelerated audio signal processing and hardware supported PPEC algorithm for speech quality improvement • All standard SCO/eSCO voice coding • All standard pairing, authentication, link key, and encryption operations • Standard Bluetooth power saving mechanism (i.e. hold, sniff modes, and sniff-sub rating) • Enhanced Power Control (EPC) • Channel Quality Driven (CQD) data rate • Wideband Speech (WBS) support (1 WBS link) • Encryption (AES) support • LTE/MWS coexistence • Bluetooth 2.1 to 5.2 Core Specification Support • Packet types <ul style="list-style-type: none"> – ACL (DM1, DH1, DM3, DH3, DM5, DH5, 2-DH1, 2-DH3, 2-DH5, 3-DH1, 3-DH3, 3-DH5) – SCO (HV1, HC3) – eSCO (EV3, EV4, EV5, 2EV3, 3EV3, 2EV5, 3EV5) • Profile Support <ul style="list-style-type: none"> – A2DP Source/Sink – AVRCP Target/Controller – HFP Dev/gateway – OPP Server/Client – PAN Traffic – SPP – HID – PBAP
Bluetooth Low Energy (LE)	<ul style="list-style-type: none"> • Broadcaster, Observer, Central, and Peripheral roles • Supports link layer topology to be master and slave (connects up to 16 links) • Shared RF with BR/EDR • Encryption AES support • Hardware support for intelligent Adaptive Frequency Hopping (AFH) • LE Privacy 1.2 • LE Secure Connection • LE Data Length Extension • LE Advertising Length Extension • High Duty Cycle Directed Advertising • 2 Mbps LE Bluetooth Low Energy 4.0 to 5.2 Support • Direction Finding <ul style="list-style-type: none"> – Connectionless Angle of Departure (AoD) – Connection-oriented Angle of Arrival (AoA) • Profile Support <ul style="list-style-type: none"> – GATT – HOGP

3 Detailed Description

3.1 Dimensions



The dimensions are in millimeters.

Top View

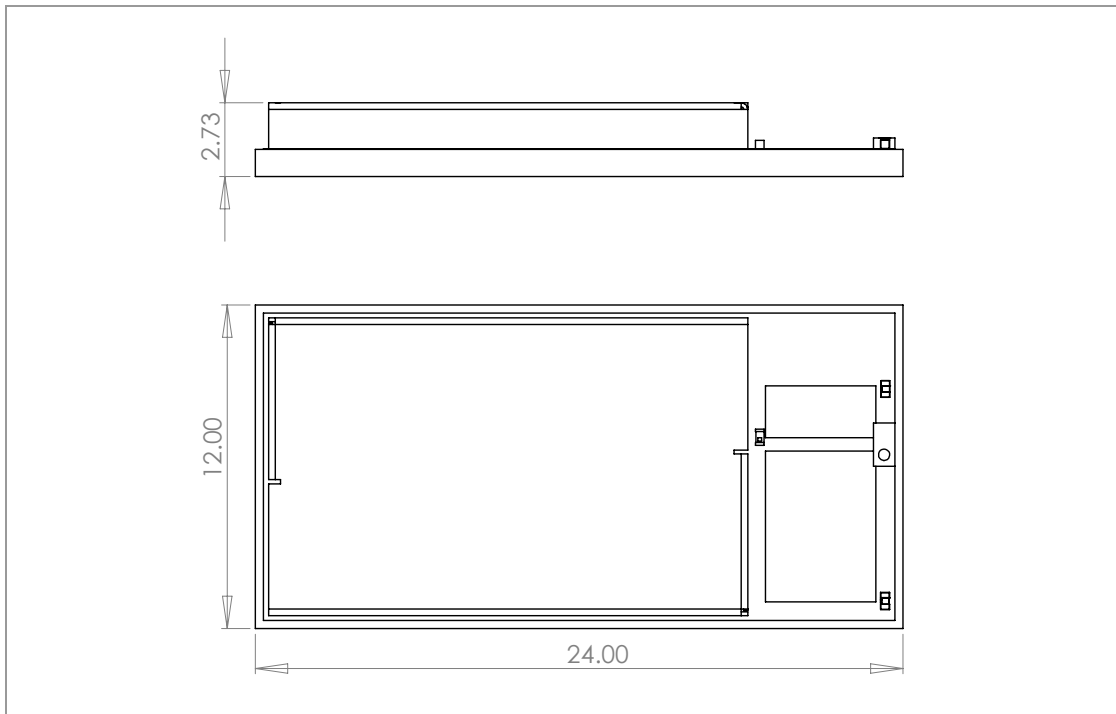

Item	Dimension	Tolerance	Remark
Width	12.00	±0.35	
Length	24.00	±0.35	
Height	2.73	±0.20	With case

3.2 Footprint

Top View



3.3 Packaging

The module is a mass production status product and will be delivered in the package described below.

3.3.1 Tape Dimensions

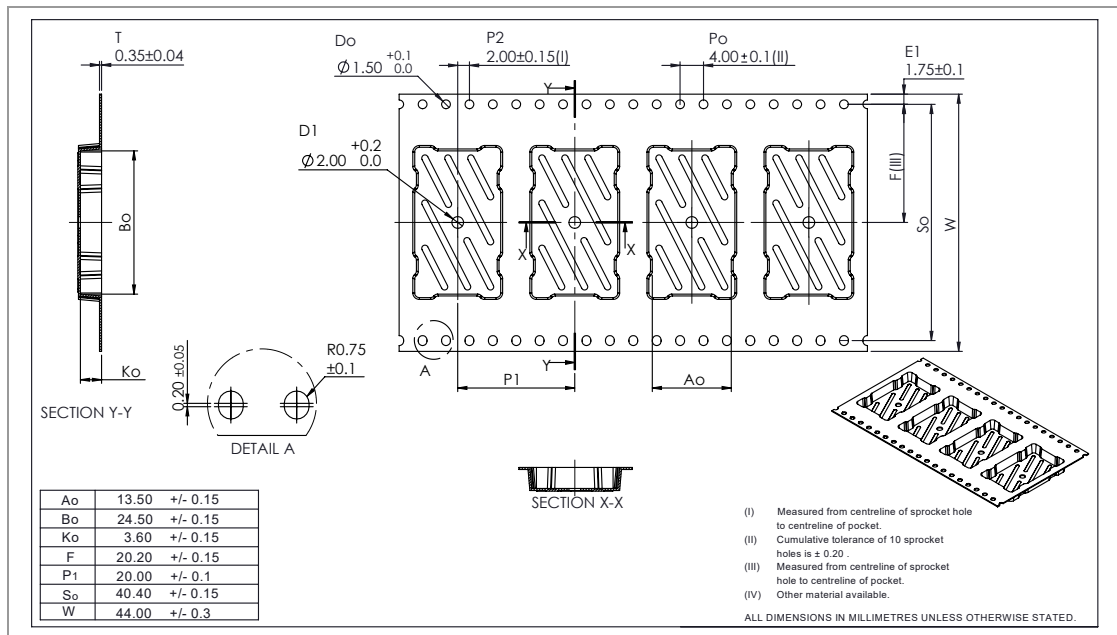

3.3.2 Packing in Tape

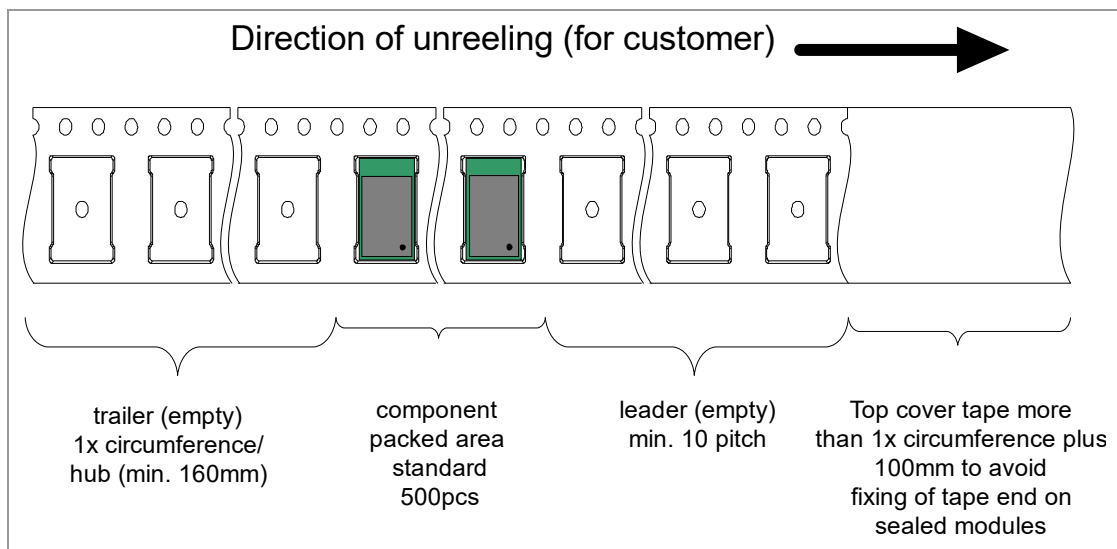

Empty spaces in the component packed area shall be less than two per reel and those spaces shall not be consecutive.

The top cover tape shall not be found on reel holes and it shall not stick out from the reel.

3.3.3 Component Direction

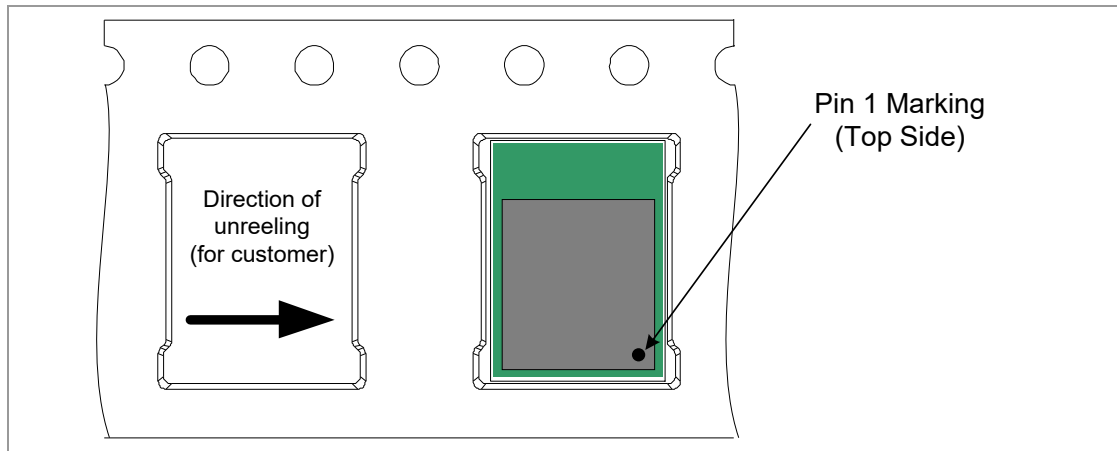

3.3.4 Reel Dimension

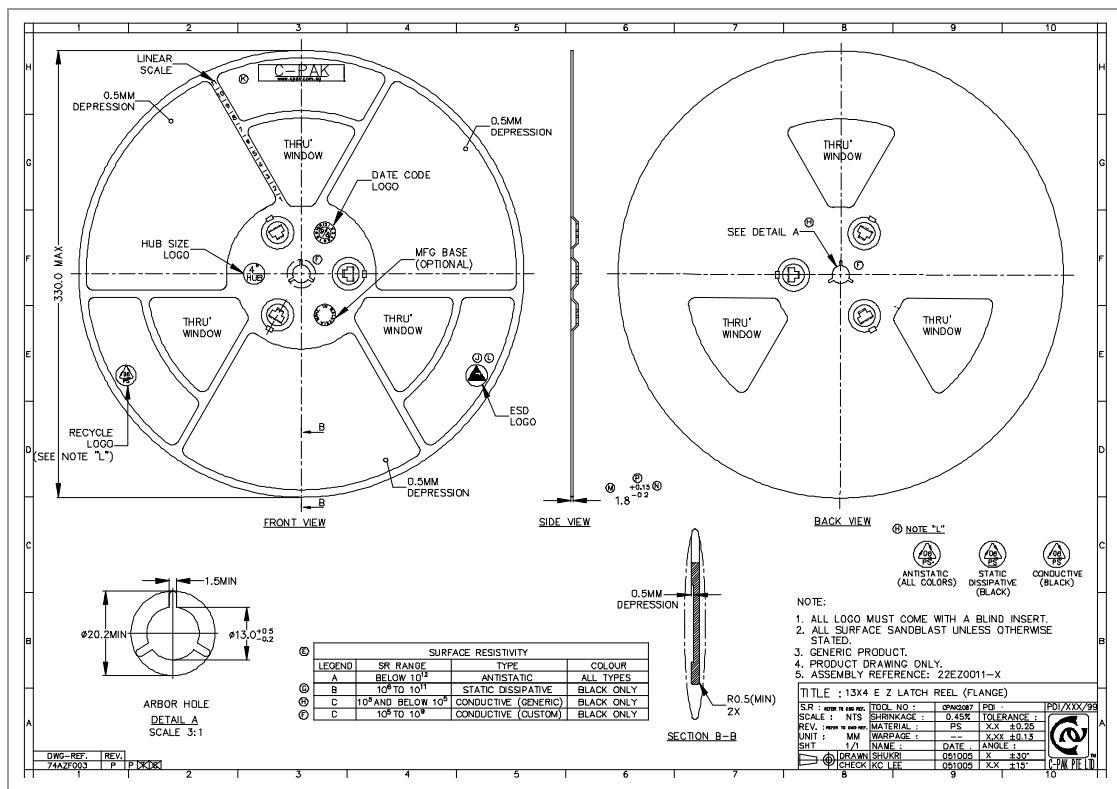

3.3.5 Package Label

Example:

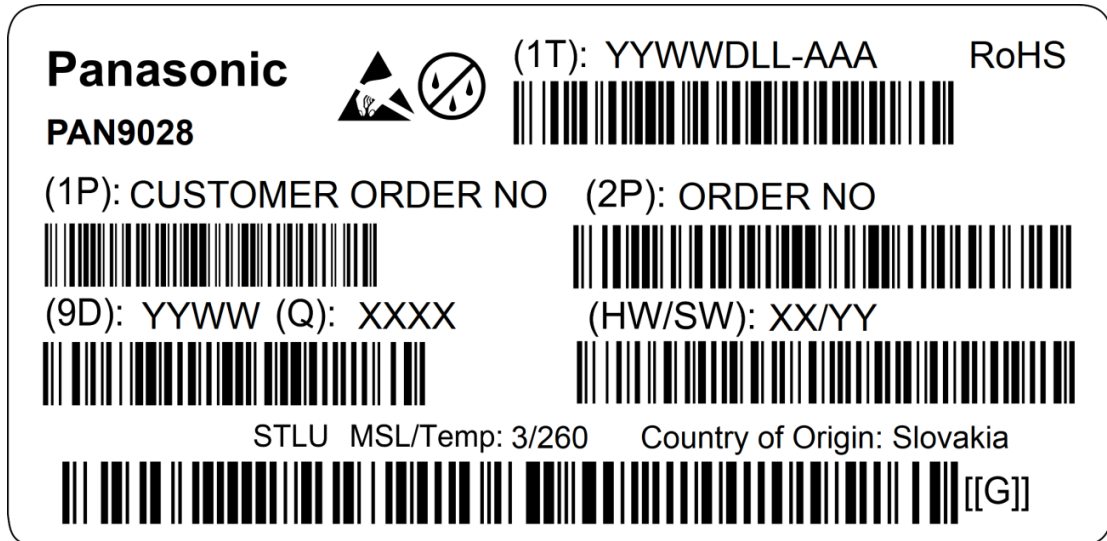

(1T)	Lot code
(1P)	Customer order number, if applicable
(2P)	Order number
(9D)	Date code
(Q)	Quantity
(HW/SW)	Hardware/software version

3.3.6 Total Package

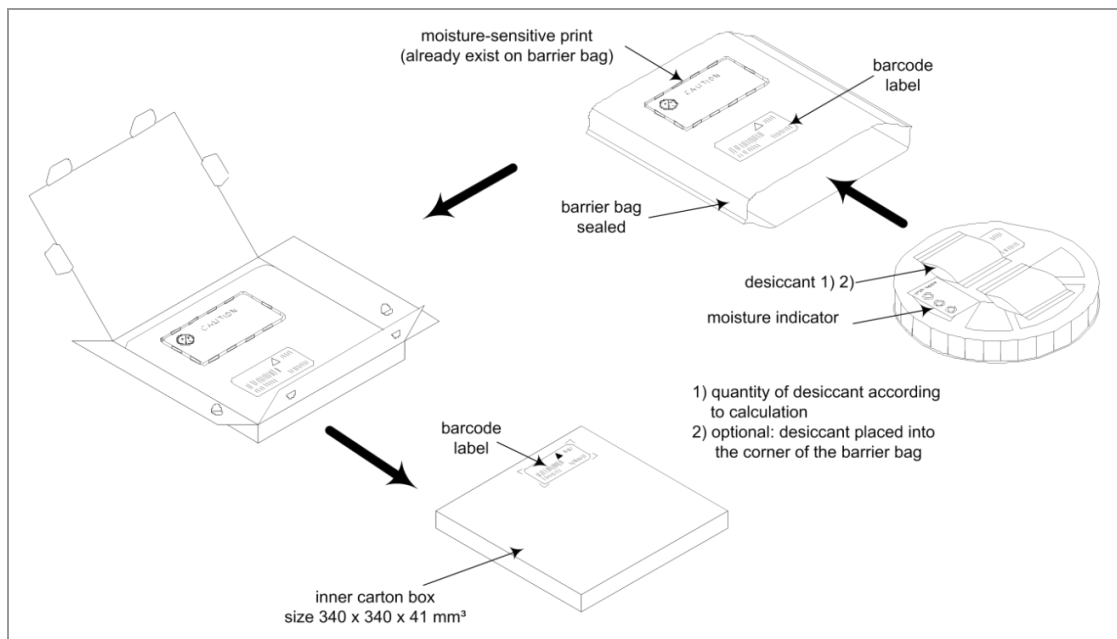

3.4 Case Marking

Example:

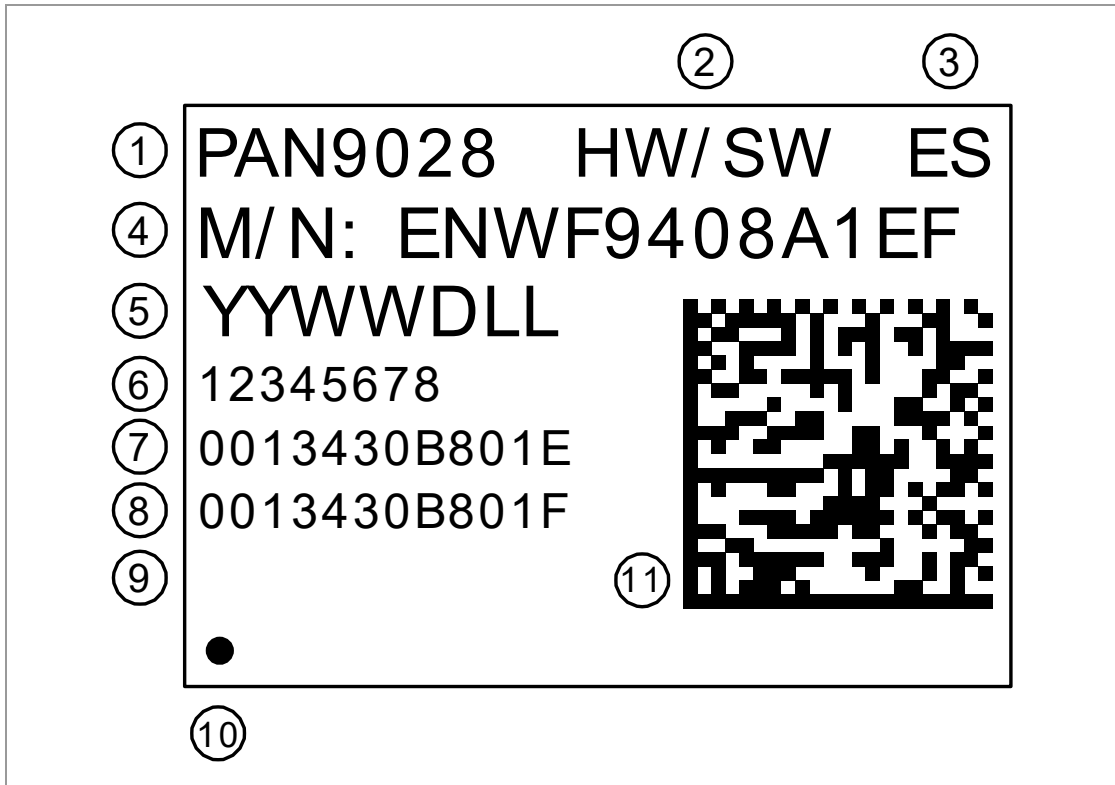

- 1 Brand name
- 2 Hardware/software version
- 3 Engineering Sample (optional)
- 4 Order number
- 5 Lot code
- 6 Serial number
- 7 WLAN MAC address
- 8 BD address
- 9 (Reserved)
- 10 Marking for Pin 1
- 11 2D barcode, for internal usage only

4 Specification



All specifications are over temperature and process, unless indicated otherwise.

4.1 Default Test Conditions



Temperature: 25 °C ± 10 °C
 Humidity: 40 to 85 % RH
 Supply Voltage: +3.3 V (for module variant ENWF490[x]A1EF)
 Supply Voltage: +3.3 V / +2.2 V / +1.8 V / +1.1 V (for module variant ENWF490[x]A2EF)

4.2 Absolute Maximum Ratings



The maximum ratings may not be exceeded under any circumstances, not even momentarily or individually, as permanent damage to the module may result.

Symbol	Parameter	Condition	Min.	Typ.	Max.	Unit
T _{STOR}	Storage temperature		-40		+85	°C
V _{ESD}	ESD robustness	All pads, according to human body model (HBM), JEDEC STD 22, method A114			1 000	V
		According to charged device model (CDM), JEDEC STD 22, method C101			500	V
P _{RF}	RF input level				+2	dBm
V _{DD3V3}	Maximum voltage	Maximum power supply voltage from any pin with respect to V _{SS} (GND)		3.3	4	V
V _{DD2V2}				2.2	2.3	V
V _{DD1V8}				1.8	1.98	V
V _{DD1V1}				1.1	1.21	V
V _{IOSD}				1.8	2.2	V
				3.3	4	V
V _{IO}				1.8	2.2	V
				3.3	4	V

Symbol	Parameter	Condition	Min.	Typ.	Max.	Unit
$V_{RF_SW1/2}$				3.3	4	V
V_{PMIC_EN}				3.3	V_{DD3V3}	V

4.3 Recommended Operating Conditions



The maximum ratings may not be exceeded under any circumstances, not even momentarily or individually, as permanent damage to the module may result.

Symbol	Parameter	Condition	Min.	Typ.	Max.	Unit
T_A	Ambient operating temperature range	Extended grade	-30		+85	°C
V_{DD3V3}	3.3 V supply voltage	V_{DD} voltage on pins F2, F3	3.07	3.3	3.53	V
V_{DD2V2}	2.2 V supply voltage	V_{DD} voltage on pins G1, G2 (only for module variant ENWF940[x]A2EF)	2.09	2.2	2.26	V
V_{DD1V8}	1.8 V supply voltage	V_{DD} voltage on pin G4 (only for module variant ENWF940[x]A2EF)	1.71	1.8	1.89	V
V_{DD1V1}	1.1 V supply voltage	V_{DD} voltage on pin A3 (only for module variant ENWF940[x]A2EF)	1.05	1.1	1.15	V
V_{IOSD}	Digital I/O VIOSD supply voltage ¹²	Pin F4 with 1.8 V operation ⇒ SDIO Pin Functions	1.67	1.8	1.92	V
		Pin F4 with 3.3 V operation ⇒ SDIO Pin Functions	3.07	3.3	3.53	V
V_{IO}	Digital I/O VIO supply voltage ¹²	Pin G3 with 1.8 V operation	1.67	1.8	1.92	V
		Pin G3 with 3.3 V operation	3.07	3.3	3.53	V
$V_{RF_SW1/2}$	$V_{RF_SW1/2}$ switch voltage	Pin A11, B11 with 3.3 V logical level switch operation ⇒ RF-Switch Pin Function	3.07	3.3	3.6	V

¹² 1.8 V or 3.3 V supply voltage possible.

Symbol	Parameter	Condition	Min.	Typ.	Max.	Unit
V _{PMIC_EN}	PMIC Enable	High Level Input Voltage Threshold (only for module variant ENWF940[x]A1EF)	1.2	3.3	3.6	V
		Low Level Input Voltage Threshold (only for module variant ENWF940[x]A1EF)	0	0	0.4	V

Digital Pin Characteristics

V_{IO} with 1.8 V Operation¹³

Symbol	Parameter	Condition	Min.	Typ.	Max.	Unit
V _{IH}	High level input voltage	1.8 V operation (V _{IO} = 1.8 V)	0.7 V _{IO}		V _{IO} + 0.4	V
V _{IL}	Low level input voltage	1.8 V operation (V _{IO} = 1.8 V)	-0.4		0.3 V _{IO}	V
V _{HYS}	Input hysteresis		100			mV
V _{OH}	High level output voltage	1.8 V operation (V _{IO} = 1.8 V)	V _{IO} - 0.4			V
V _{HO}	Low level output voltage	1.8 V operation (V _{IO} = 1.8 V)			0.4	V

V_{IO} with 3.3 V Operation¹³

Symbol	Parameter	Condition	Min.	Typ.	Max.	Unit
V _{IH}	High level input voltage	3.3 V operation (V _{IO} = 3.3 V)	0.7 V _{IO}		V _{IO} + 0.4	V
V _{IL}	Low level input voltage	3.3 V operation (V _{IO} = 3.3 V)	-0.4		0.3 V _{IO}	V
V _{HYS}	Input hysteresis		100			mV
V _{OH}	High level output voltage	3.3 V operation (V _{IO} = 3.3 V)	V _{IO} - 0.4			V
V _{HO}	Low level output voltage	3.3 V operation (V _{IO} = 3.3 V)			0.4	V

¹³ The capacitive load should not be larger than 50 pF for all I/Os when using the default driver strength settings. Large capacitive loads increase the overall current consumption.

$V_{IO\text{SD}}$ with 1.8 V Operation for SDIO I/F¹³

Symbol	Parameter	Condition	Min.	Typ.	Max.	Unit
V_{IH}	High level input voltage	1.8 V operation ($V_{IO\text{SD}} = 1.8 \text{ V}$)	$0.7 V_{IO}$		$V_{IO} + 0.4$	V
V_{IL}	Low level input voltage	1.8 V operation ($V_{IO\text{SD}} = 1.8 \text{ V}$)	-0.4		$0.3 V_{IO}$	V
V_{HYS}	Input hysteresis		100			mV
V_{OH}	High level output voltage	1.8 V operation ($V_{IO\text{SD}} = 1.8 \text{ V}$)	$V_{IO} - 0.4$			V
V_{HO}	Low level output voltage	1.8 V operation ($V_{IO\text{SD}} = 1.8 \text{ V}$)			0.4	V

$V_{IO\text{SD}}$ with 3.3 V Operation for SDIO I/F¹³

Symbol	Parameter	Condition	Min.	Typ.	Max.	Unit
V_{IH}	High level input voltage	3.3 V operation ($V_{IO\text{SD}} = 3.3 \text{ V}$)	$0.7 V_{IO}$		$V_{IO} + 0.4$	V
V_{IL}	Low level input voltage	3.3 V operation ($V_{IO\text{SD}} = 3.3 \text{ V}$)	-0.4		$0.3 V_{IO}$	V
V_{HYS}	Input hysteresis		100			mV
V_{OH}	High level output voltage	3.3 V operation ($V_{IO\text{SD}} = 3.3 \text{ V}$)	$V_{IO} - 0.4$			V
V_{HO}	Low level output voltage	3.3 V operation ($V_{IO\text{SD}} = 3.3 \text{ V}$)			0.4	V

4.4 Current Consumption

4.4.1 For ENWF940[x]A1EF



The current consumption depends on the user scenario and on the setup and timing in the power modes. Following current consumptions are valid for module variant ENWF940[x]A1EF.

Assume $V_{DD} = 3.3 \text{ V}$, $T_{amb} = 25 \text{ }^\circ\text{C}$, if nothing else stated.

Parameter	Condition	Min.	Typ.	Max.	Unit
$I_{VDD3V3} @ \text{PMIC_EN}$	Power Down	Grounding of PMIC_EN pin	0.25		mA
$I_{VDD3V3} @ \text{DeepSleep}$	Deep Sleep	Low-power state used in sleep state (Wi-Fi and Bluetooth)	0.50		mA
$I_{VDD3V3} @ \text{Firmware Init}$	Firmware Initialization	Device Initialization		800	mA

WLAN Current Consumption

Symbol	Parameter	Condition	Min.	Typ.	Max.	Unit
I _{VDD3V3 @ TX}	Active Transmit ¹⁴	P _{TX} = +16 dBm for 5 GHz band 802.11a at 54 Mbps		330		mA
		P _{TX} = +15 dBm for 5 GHz band 802.11n 40 MHz at 150 Mbps		280		mA
		P _{TX} = +10 dBm for 5 GHz band 802.11ac 80 MHz at 433 Mbps		240		mA
		P _{TX} = +16 dBm for 2.4 GHz band 802.11b at 11 Mbps		290		mA
		P _{TX} = +16 dBm for 2.4 GHz band 802.11g at 54 Mbps		250		mA
		P _{TX} = +16 dBm for 2.4 GHz band 802.11n 20 MHz at 72 Mbps		240		mA
I _{VDD3V3 @ RX}	Active Receive ¹⁴	5 GHz band 802.11a at 54 Mbps		80		mA
		5 GHz band 802.11n 40 MHz at 150 Mbps		90		mA
		5 GHz band 802.11ac 80 MHz at 433 Mbps		100		mA
		2.4 GHz band 802.11b at 11 Mbps		70		mA
		2.4 GHz band 802.11g at 54 Mbps		70		mA
		2.4 GHz band 802.11n 20 MHz at 72 Mbps		70		mA

Bluetooth Current Consumption

Symbol	Parameter	Condition	Min.	Typ.	Max.	Unit
I _{VDD3V3 @ TX}	BT SCO HV3	Peak, P _{TX} = +4 dBm		25		mA
	Peak LE	Peak, P _{TX} = +0 dBm		25		mA
I _{VDD3V3 @ RX}	BT SCO HV3	Peak		20		mA
	Peak LE	Peak		23		mA
I _{SCAN BT}	Page & Inquiry Scan	Average		0.8		mA
I _{ADV LE}	LE Advertise	Interval = 1.28 s, Average		0.6		mA

¹⁴ Peak values for specified output power level and data rate with UDP traffic between the AP and Device (STA).

4.4.2 For ENWF940[x]A2EF



The current consumption depends on the user scenario, on the setup, and timing in the power modes. Following current consumptions are valid for module variant ENWF940[x]A2EF.

Assume $V_{DD3V3} = 3.3\text{ V}$, $V_{DD2V2} = 2.2\text{ V}$, $V_{DD1V8} = 1.8\text{ V}$, $V_{DD1V1} = 1.1\text{ V}$ and $T_{amb} = 25\text{ }^{\circ}\text{C}$, if nothing else stated.

Symbol	Parameter	Condition	Min.	Typ.	Max.	Unit
I_{VDD2V2}	Deep Sleep	Low-power state used in sleep state (Wi-Fi and Bluetooth)		0.003		mA
I_{VDD1V8}		Low-power state used in sleep state (Wi-Fi and Bluetooth)		0.050		mA
I_{VDD1V1}		Low-power state used in sleep state (Wi-Fi and Bluetooth)		1.200		mA
I_{VDD1V1}		Low-power state used in sleep state (Wi-Fi and Bluetooth), Reduced core voltage from 1.1 V to 0.8 V after set to Deep Sleep.		0.400		mA
I_{VDD2V2}	Firmware Initialization	Device Initialization			900	mA
I_{VDD1V8}					200	mA
I_{VDD1V1}					200	mA

WLAN Current Consumption

Symbol	Parameter	Condition	Min.	Typ.	Max.	Unit
$I_{VDD2V2} @ TX$	Active Transmit ¹⁴	$P_{TX} = +16$ for 5 GHz band 802.11a at 54 Mbps		220		mA
		$P_{TX} = +15$ dBm for 5 GHz band 802.11n 40 MHz at 150 Mbps		160		mA
		$P_{TX} = +10$ dBm for 5 GHz band 802.11ac 80 MHz at 433 Mbps		110		mA
		$P_{TX} = +16$ dBm for 2.4 GHz band 802.11b at 11 Mbps		240		mA
		$P_{TX} = +16$ dBm for 2.4 GHz band 802.11g at 54 Mbps		180		mA
		$P_{TX} = +16$ dBm for 2.4 GHz band 802.11n 20 MHz at 72 Mbps		180		mA
$I_{VDD2V2} @ RX$	Active Receive ¹⁴	5 GHz band 802.11a at 54 Mbps		0		mA
		5 GHz band 802.11n 40 MHz at 150 Mbps		0		mA
		5 GHz band 802.11ac 80 MHz at 433 Mbps		0		mA
		2.4 GHz band 802.11b at 11 Mbps		0		mA
		2.4 GHz band 802.11g at 54 Mbps		0		mA

Symbol	Parameter	Condition	Min.	Typ.	Max.	Unit
		2.4 GHz band 802.11n 20 MHz at 72 Mbps		0		mA
I _{VDD1V8 @ TX}	Active Transmit ¹⁴	P _{TX} = +16 dBm for 5 GHz band 802.11a at 54 Mbps		120		mA
		P _{TX} = +15 dBm for 5 GHz band 802.11n 40 MHz at 150 Mbps		120		mA
		P _{TX} = +10 dBm for 5 GHz band 802.11ac 80 MHz at 433 Mbps		120		mA
		P _{TX} = +16 dBm for 2.4 GHz band 802.11b at 11 Mbps		70		mA
		P _{TX} = +16 dBm for 2.4 GHz band 802.11g at 54 Mbps		70		mA
		P _{TX} = +16 dBm for 2.4 GHz band 802.11n 20 MHz at 72 Mbps		70		mA
I _{VDD1V8 @ RX}	Active Receive ¹⁴	5 GHz band 802.11a at 54 Mbps		70		mA
		5 GHz band 802.11n 40 MHz at 150 Mbps		70		mA
		5 GHz band 802.11ac 80 MHz at 433 Mbps		70		mA
		2.4 GHz band 802.11b at 11 Mbps		50		mA
		2.4 GHz band 802.11g at 54 Mbps		50		mA
		2.4 GHz band 802.11n 20 MHz at 72 Mbps		50		mA
I _{VDD1V1 @ TX}	Active Transmit ¹⁴	P _{TX} = +16 dBm for 5 GHz band 802.11a at 54 Mbps		120		mA
		P _{TX} = +15 dBm for 5 GHz band 802.11n 40 MHz at 150 Mbps		120		mA
		P _{TX} = +10 dBm for 5 GHz band 802.11ac 80 MHz at 433 Mbps		130		mA
		P _{TX} = +16 dBm for 2.4 GHz band 802.11b at 11 Mbps		120		mA
		P _{TX} = +16 dBm for 2.4 GHz band 802.11g at 54 Mbps		110		mA
		P _{TX} = +16 dBm for 2.4 GHz band 802.11n 20 MHz at 72 Mbps		110		mA
I _{VDD1V1 @ RX}	Active Receive ¹⁴	5 GHz band 802.11a at 6 Mbps		70		mA
		5 GHz band 802.11n 20 MHz at 72 Mbps		70		mA
		5 GHz band 802.11ac 80 MHz at 433 Mbps		70		mA
		2.4 GHz band 802.11b at 11 Mbps		60		mA
		2.4 GHz band 802.11g at 54 Mbps		60		mA
		2.4 GHz band 802.11n 20 MHz at 72 Mbps		60		mA

Bluetooth Current Consumption

Symbol	Parameter	Condition	Min.	Typ.	Max.	Unit
I _{VDD2V2 @ TX}	BT SCO HV3	Peak, P _{TX} = +4 dBm		0		mA
	Peak LE	Peak, P _{TX} = +0 dBm		0		mA
I _{VDD2V2 @ RX}	BT SCO HV3	Peak		0		mA
	Peak LE	Peak		0		mA
I _{VDD1V8 @ TX}	BT SCO HV3	Peak, P _{TX} = +4 dBm		20		mA
	Peak LE	Peak, P _{TX} = +0 dBm		20		mA
I _{VDD1V8 @ RX}	BT SCO HV3	Peak		20		mA
	Peak LE	Peak		20		mA
I _{VDD1V1 @ TX}	BT SCO HV3	Peak, P _{TX} = +4 dBm		25		mA
	Peak LE	Peak, P _{TX} = +0 dBm		25		mA
I _{VDD1V1 @ RX}	BT SCO HV3	Peak		20		mA
	Peak LE	Peak		20		mA
I _{VDD2V2 SCAN BT}	Page & Inquiry Scan	Average		0		mA
I _{VDD1V8 SCAN BT}	Page & Inquiry Scan	Average		0.5		mA
I _{VDD1V1 SCAN BT}	Page & Inquiry Scan	Average		0.9		mA
I _{VDD2V2 ADV LE}	LE Advertise	Interval = 1.28s, Average		0		mA
I _{VDD1V8 ADV LE}	LE Advertise	Interval = 1.28s, Average		0.3		mA
I _{VDD1V1 ADV LE}	LE Advertise	Interval = 1.28s, Average		0.8		mA

4.5 Internal Operating Frequencies

Symbol	Parameter	Condition	Min.	Typ.	Max.	Unit
f _{SYCLK1}	CPU1/System/Encryption clock speed	Refers to clock speed of SoC's CPU1			256	MHz
f _{SYCLK2}	CPU2	Refers to clock speed of SoC's CPU2			64	MHz
f _{REFCLK1}	Crystal fundamental frequency	Frequency tolerance < ±10 ppm over operating temperature and process		26		MHz
f _{SLEEPCLK} (only for module variant ENWF940[x]A1E F)	Sleep Clock frequency	Frequency tolerance < ±30 ppm over operating temperature, aging and process, CMOS input clock signal type		32.768		kHz

4.6 External Sleep Clock Specifications

An external sleep clock of 32.768 kHz can be used for lowest current consumption in sleep mode. Voltage level of external sleep clock must be the same value which is used for Pin G4 (V_{IO}).

Parameter	Min.	Typ.	Max.	Unit
Clock frequency range/accuracy <ul style="list-style-type: none"> • CMOS input clock signal type • ±250 ppm (initial, aging, temperature) 		32.768		kHz
Phase noise requirement (at 100 kHz)		-125		dBc/Hz
Cycle jitter		1.5		ns (RMS)
Slew rate limit (10 % to 90 %)			100	ns
Duty cycle tolerance	20		80	%

4.7 Power-up Sequence

For Module Variant ENWF940[x]A1EF



A minimum time of 100 ms is required after PMIC_EN is de-asserted (low) and before it is asserted (high).

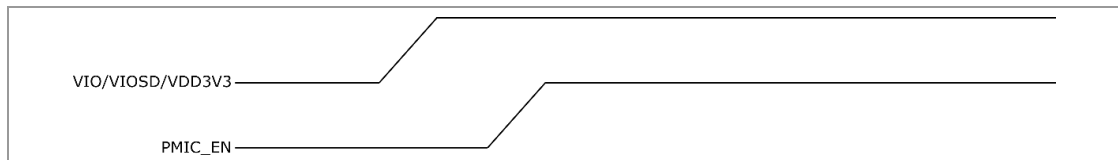

For Module Variant ENWF940[x]A2EF

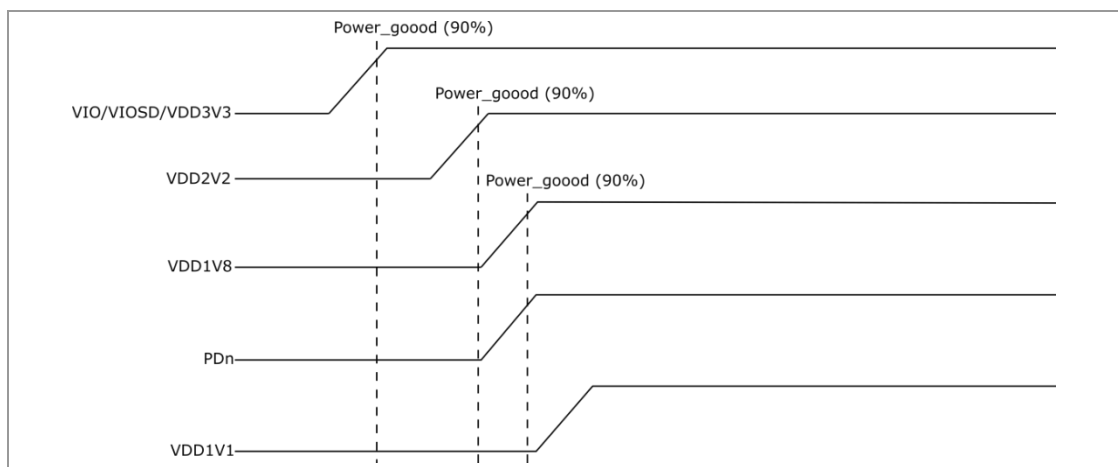

- $V_{IO}/V_{IOSD}/V_{DD3V3}$ must be good (90 %) before or at the same time all other power supplies start ramping up.
- $V_{IO}/V_{IOSD}/V_{DD3V3}$ must be good (90 %) before or at the same time PDn starts ramping up.
- V_{DD2V2} must be good (90 %) before or at the same time V_{DD1V8} starts ramping up.
- It is recommended to start ramping up $V_{DD1V8} \leq 1\text{ms}$ after V_{DD2V2} ramps up.
- V_{DD1V8} must be good (90 %) before or at the same time V_{DD1V1} starts ramping up.
- Ramp-up time of $V_{IO}/V_{IOSD}/V_{DD3V3}$ must be $< 100\text{ms}$.
- Ramp-up time of V_{DD2V2}/V_{DD1V8} must be $< 100\text{ms}$.
- Ramp-up time of V_{DD1V1} must be $< 5\text{ms}$.
- All supplies must be monotonic.

4.8 Power-down Sequence

For Module Variant ENWF940[x]A1EF

Power down sequencing is performed from internal power management IC after PMIC_EN pin is pulled to low state.

For Module Variant ENWF940[x]A2EF

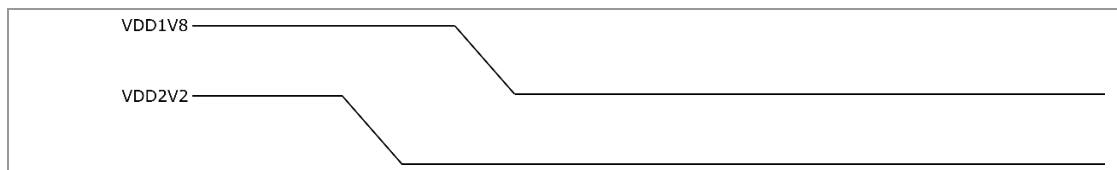

- It is recommended to ramp down V_{DD1V8} after V_{DD2V2} ramps down.
- It is recommended to discharge all of the power supplies to less than 0.2 V to reduce leakage.
- PDn must be asserted when powering down the module.

4.9 Power Good (for Module Variant ENWF940[x]A1EF)



If the power good outputs (PG1, PG2, PGLDO) are not used, do not connect.

The PAN9028 contains power good comparators, which pull the signal to a logical low level, when the associated output voltage drops below 90 % of its regulated value. Also, when the associated rising output voltage is above 95 % of its regulated value, the power good comparators pull the signal to a logical low level.

No.	Pin Name	Pin Type	Logical Level	
			Low (typ. 0 V)	High (typ. 3.3 V)
B1	PG1	Output signal	1.1 V voltage supply not stabilized	1.1 V voltage supply stabilized
D1	PG2	Output signal	2.2 V voltage supply not stabilized	2.2 V voltage supply stabilized
C1	PGLDO	Output signal	1.8 V voltage supply not stabilized	1.8 V voltage supply stabilized

4.10 Interfaces

4.10.1 Host Interface

4.10.1.1 SDIO Interface



The SDIO Interface pins are powered from the V_{IOSD} voltage supply with 3.3 V or 1.8 V. The SDIO electrical specifications are identical for the 1-bit and 4-bit SDIO modes.

For DC specifications please refer to “Digital Pin Characteristics” ⇒ [4.3 Recommended Operating Conditions](#).

SDIO Timing Data – Default and High-Speed Modes (V_{IOSD} 3.3 V)^{15,16}

Symbol	Parameter	Condition	Min.	Typ.	Max.	Unit
f_{PP}	Clock frequency	Normal	0		25	MHz
		High-speed	0		50	MHz
T_{WL}	Clock low time	Normal	10			ns
		High-speed	7			ns

¹⁵ For SDIO 2.0 running at 50 MHz clock frequency, a supply voltage V_{IOSD} of 1.8 V is recommended.

¹⁶ For SDIO 2.0 running at 25 MHz clock frequency, 1.8 V or 3.3 V can be used.

Symbol	Parameter	Condition	Min.	Typ.	Max.	Unit
T _{WH}	Clock high time	Normal	10			ns
		High-speed	7			ns
T _{ISU}	Input setup time	Normal	5			ns
		High-speed	6			ns
T _{IH}	Input hold time	Normal	5			ns
		High-speed	2			ns
T _{ODLY}	Output delay time	Normal			14	ns
	CL ≤ 40 pF (1 card)	High-speed			14	ns
T _{OH}	Output hold time	High-speed	2.5			ns

SDIO Protocol Timing Diagram – Default Speed Mode (V_{IOSD} 3.3 V)

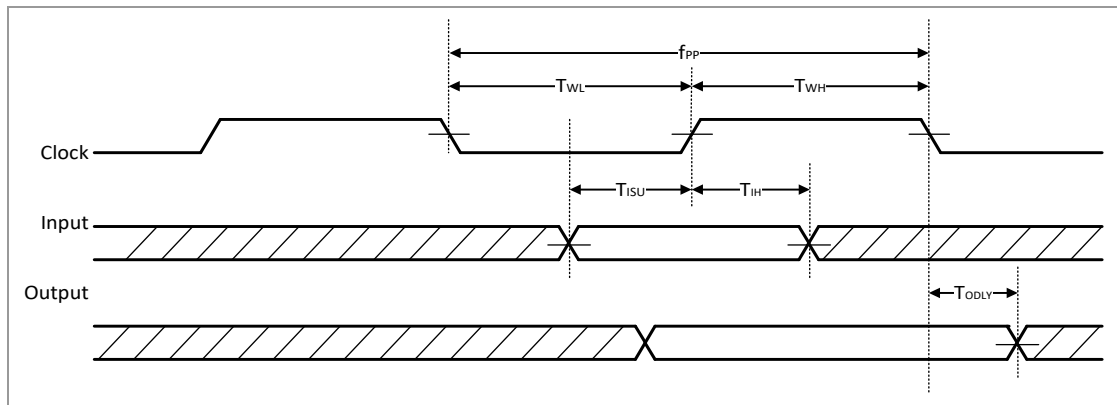

SDIO Protocol Timing Diagram – High-Speed Mode (V_{IOSD} 3.3 V)

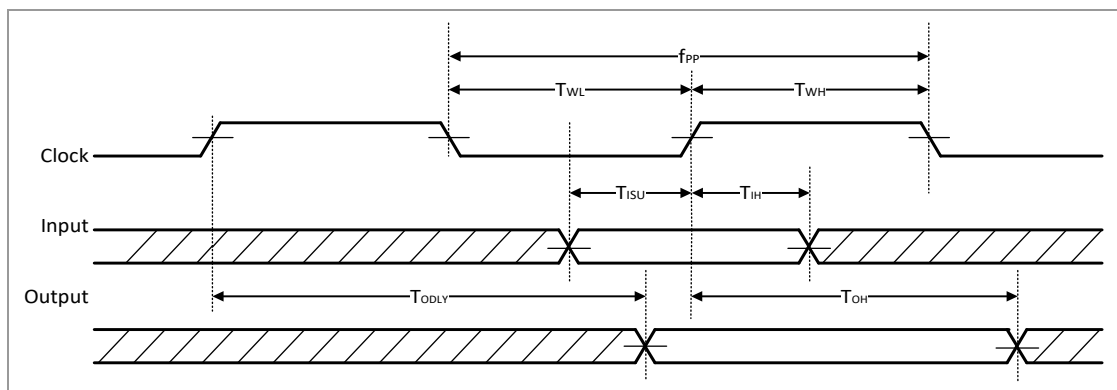

SDIO Timing Data – SDR12, SDR25, SDR50 Modes (V_{IOSD} 1.8 V)

Symbol	Parameter	Condition	Min.	Typ.	Max.	Unit
f _{PP}	Clock frequency	SDR12/SDR25/SDR50	25		100	MHz
T _{IS}	Input setup time	SDR12/SDR25/SDR50	3			ns
T _{IH}	Input hold time	SDR12/SDR25/SDR50	0.8			ns
T _{CLK}	Clock time	SDR12/SDR25/SDR50	10		40	ns
T _{CR} , T _{CF}	Rise time, fall time T _{CR} , T _{CF} < 2 ns (max) at 100 MHz C _{CARD} = 10 pF	SDR12/SDR25/SDR50			0.2 T _{CLK}	ns
T _{ODLY}	Output delay time CL ≤ 30 pF	SDR12/SDR25/SDR50			7.5	ns
T _{OH}	Output hold time CL ≤ 15 pF	SDR12/SDR25/SDR50	1.5			ns

SDIO Protocol Timing Diagram – SDR12, SDR25, SDR50 Modes (V_{IOSD} 1.8 V)

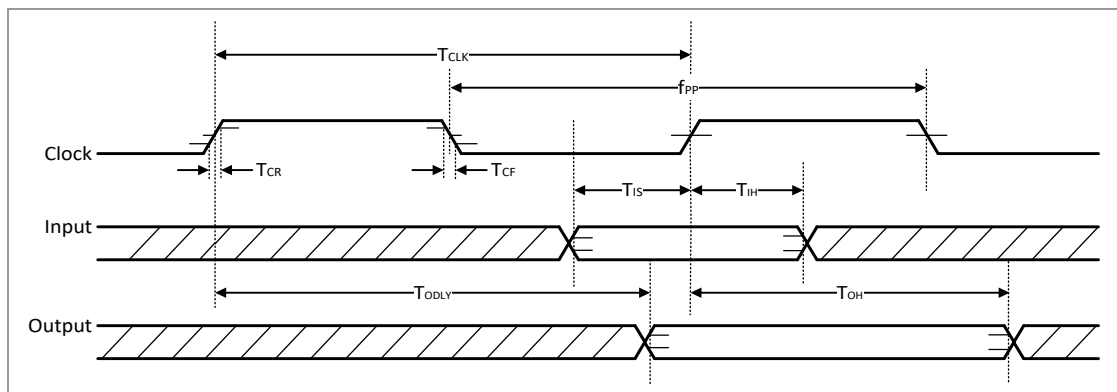

SDIO Timing Data – SDR104 Mode (V_{IOSD} 1.8 V)

Symbol	Parameter	Condition	Min.	Typ.	Max.	Unit
f _{PP}	Clock frequency	SDR104	0		208	MHz
T _{IS}	Input setup time	SDR104	1.4			ns
T _{IH}	Input hold time	SDR104	0.8			ns
T _{CLK}	Clock time	SDR104	4.8			ns
T _{CR} , T _{CF}	Rise time, fall time T _{CR} , T _{CF} < 0.96 ns (max) at 208 MHz C _{CARD} = 10 pF	SDR104			0.2 T _{CLK}	ns
T _{OP}	Card output phase	SDR104	0		10	ns
T _{ODW}	Output timing of variable data window	SDR104	2.88			ns

SDIO Protocol Timing Diagram – SDR104 Mode ($V_{IOSD} 1.8 V$)

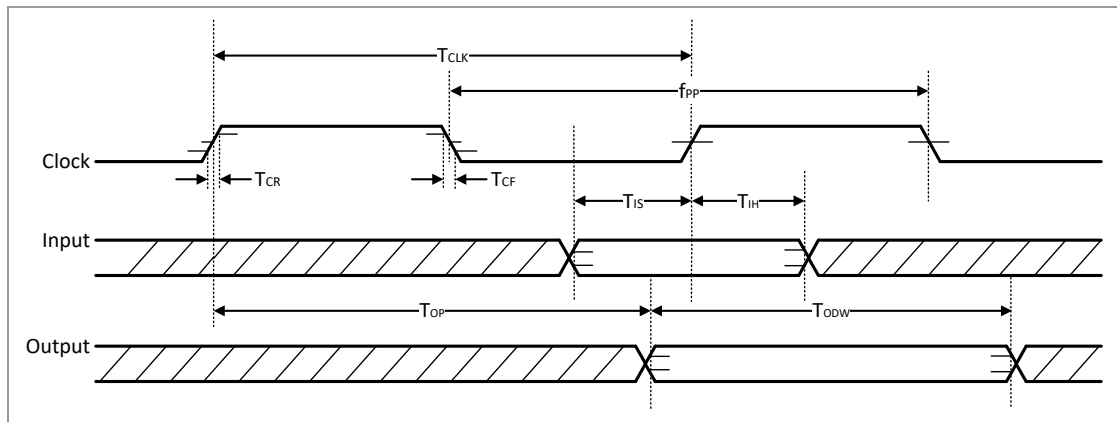

SDIO Timing Data – DDR50 Mode ($V_{IOSD} 1.8 V$)

Symbol	Parameter	Condition	Min.	Typ.	Max.	Unit
Clock						
T_{CLK}	Clock time 50 MHz (max) between rising edges	DDR50	20			ns
T_{CR}, T_{CF}	Rise time, fall time $T_{CR}, T_{CF} < 4.00$ ns (max) at 50 MHz $C_{CARD} = 10$ pF	DDR50			$0.2 T_{CLK}$	ns
Clock Duty		DDR50	45		55	%
CMD Input (referenced to clock rising edge)						
T_{IS}	Input setup time $C_{CARD} \leq 10$ pF (1 card)	DDR50	6			ns
T_{IH}	Input hold time $C_{CARD} \leq 10$ pF (1 card)	DDR50	0.8			ns
CMD Output (referenced to clock rising edge)						
T_{OLDY}	Output delay time during data transfer mode $C_L \leq 30$ pF (1 card)	DDR50			13.7	ns
$T_{OHL D}$	Output hold time $C_L \leq 15$ pF (1 card)	DDR50	1.5			ns
DAT[3:0] Input (referenced to clock rising and falling edges)						
T_{IS2x}	Input setup time $C_{CARD} \leq 10$ pF (1 card)	DDR50	3			ns
T_{IH2x}	Input hold time $C_{CARD} \leq 10$ pF (1 card)	DDR50	0.8			ns

Symbol	Parameter	Condition	Min.	Typ.	Max.	Unit
DAT[3:0] Output (referenced to clock rising and falling edges)						
TODLY2x (max)	Output delay time during data transfer mode $C_L \leq 25 \text{ pF}$ (1 card)	DDR50			7	ns
TODLY2x (min)	Output hold time $C_L \leq 15 \text{ pF}$ (1 card)	DDR50	1.5			ns

SDIO CMD Timing Diagram – DDR50 Mode ($V_{IO\text{SD}} 1.8 \text{ V}$, 50 MHz)

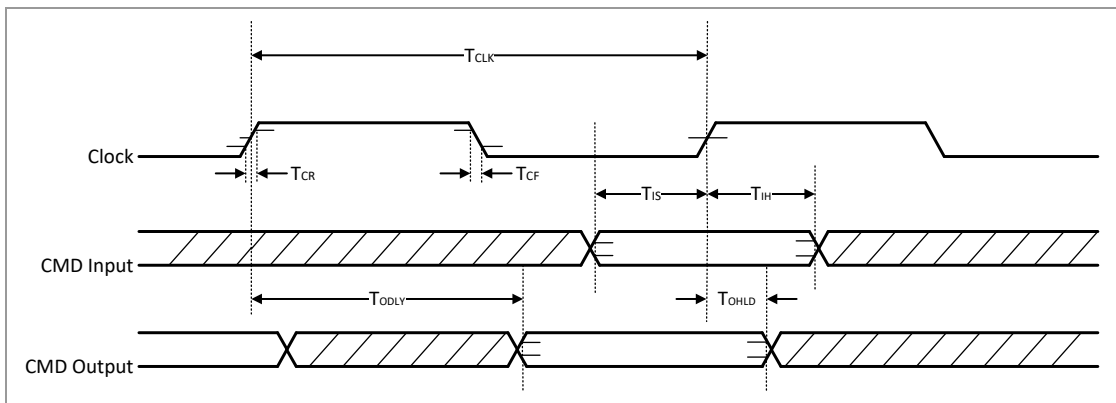

SDIO DAT[3:0] Timing Diagram – DDR50 Mode ($V_{IO\text{SD}} 1.8 \text{ V}$, 50 MHz)

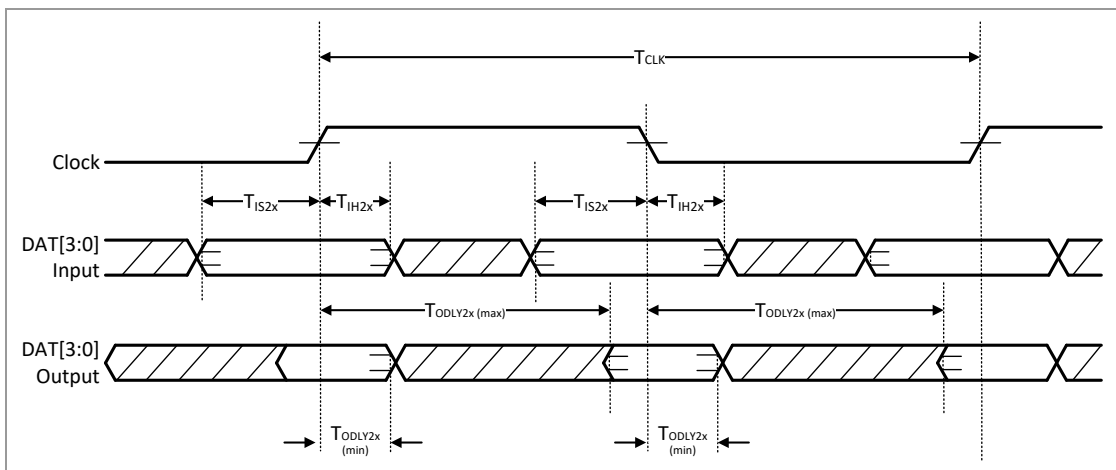

4.10.1.2 High-Speed UART Interface



The High-Speed UART Interface pins are powered from the V_{IO} voltage supply with 3.3 V or 1.8 V.

For DC specifications please refer to “Digital Pin Characteristics” ⇒ [4.3 Recommended Operating Conditions](#).

The UART interface operation includes:

- Support data input/output operations for peripheral devices connected through a standard UART interface
- 4-wire data transfer (RxD, TxD, RTS and CTS) or 6-wire data transfer (RxD, TxD, RTS, CTS, DSR, and DTR)
- Programmable baud rate (1 200 bps to 4 Mbps)
- Data format (LSB first)
- Data bit: (5 bit to 8 bit)
- Parity bit: (0 bit to 4 bit)
- Stop bit: (1 bit to 2 bit)

Interface Signals

Pin No.	Signal Name	Specification Name	Type	Description
B8	UART_SOUT	TxD	Host Controller Interface (HCI)	Transmit data output
A8	UART_SIN	RxD		Receive data input
A7	UART_RTS	RTS		Request to send (active low)
A6	UART_CTS	CTS		Clear to send (active low)
B6	UART_DSR	DSR	optional	Data set ready (active low)
B7	UART_DTR	DTR		Data terminal ready (active low)

Interface Transport Settings

Item	Range	Default	Comment
Baud Rate	1 200 ~ 4 000 000	3 000 000	Baud
Data Bits	5 ~ 8	8	LSB first
Parity Bits	0 ~ 4	0	
Stop Bits	1/1.5/2	1	

Supported Baud Rates

Baud Rate				
1 200	2 400	4 800	9 600	19 200
38 400	57 600	76 800	115 200	230 400
460 800	500 000	921 600	1 000 000	1 382 400
1 500 000	1 843 200	2 000 000	2 100 000	2 764 800
3 000 000	3 250 000	3 692 300	4 000 000	

UART Timing Diagram

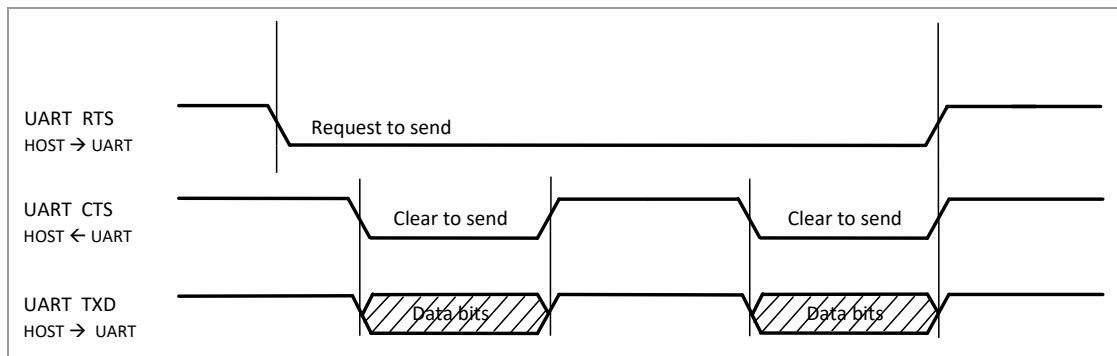

4.10.2 Peripheral Interface



The Peripheral Interface pins are powered from the V_{IO} voltage supply with 3.3 V or 1.8 V.

For DC specifications please refer to “Digital Pin Characteristics” ⇒ [4.3 Recommended Operating Conditions](#).

GPIO Interface

The General-Purpose I/O (GPIO) interface is used to implement user-defined input and output signals to and from the device, such as external interrupts and other user-defined I/Os.

Configurable GPIOs

Function	GPIO Pin Name									
	IO0	IO1	IO2	IO3	IO4	IO5	IO6	IO7	IO8	IO9
GPIO IN	YES	YES	YES	YES	YES	YES	YES	YES	YES	YES
GPIO OUT	YES	YES	YES	YES	YES	YES	YES	YES	YES	YES
IRQ IN	YES	YES	YES	YES	YES	YES	YES	YES	YES	YES
LED	NO	NO	YES	YES	NO	NO	NO	NO	NO	NO

Function	GPIO Pin Name								
	IO10	IO11	IO12	IO13	IO14	IO15	IO16	IO17	IO20
GPIO IN	YES	YES	YES	YES	YES	YES	YES	YES	YES
GPIO OUT	YES	YES	YES	YES	YES	YES	YES	YES	YES
IRQ IN	YES	YES	YES	YES	YES	YES	YES	YES	YES
LED	NO	NO	NO	NO	NO	NO	NO	NO	NO

LED Mode

Symbol	Parameter	Condition	Typ.	Unit
I_{OH}	Switching current high	Tristate on pin (requires pull-up)	Tristate when driving high	mA
I_{OL}	Switching current low	At 0.4 V	10	mA

4.10.3 Audio Interface: PCM Interface

Interface Signals

Pin No.	Signal Name	Specification Name	Type	Description
F7	PCM_DOUT	DOUT	Output	PCM data
E1	PCM_CLK	CLK	Input/Output	PCM clock signal, output if PCM master, input if PCM slave
E1	PCM_MCLK	MCLK	Output	PCM clock signal (optional), optional clock used for some codecs, derived from PCM_CLK
E11	PCM_DIN	DIN	Input	PCM data
F6	PCM_SYNC	SYNC	Input/Output	PCM Synchronization pulse signal, output if PCM master, input if PCM slave

Modes of Operation

The PCM Interface supports two modes of operation:

- PCM master
- PCM slave

In PCM master mode, the interface generates a 2 MHz or a 2.048 MHz PCM_CLK and a 8 kHz PCM_SYNC signal. An alternative PCM master mode is available that uses an externally generated PCM_CLK, but still generate the 8 kHz PCM_SYNC. The external PCM_CLK must have a frequency that is an integer multiple of 8 kHz. Supported frequencies are in the 512 kHz to 4 MHz range.

In PCM slave mode, the interface has both PCM_CLK and PCM_SYNC as inputs, thereby letting another unit on the PCM bus generate the signals.

The PCM interface consists of up to four PCM slots (time-divided) preceded by a PCM synchronization signal. Each PCM slot can be 8 bits or 16 bits wide. The slots can be separated in time, but they are not required to follow immediately after another. The timing is relative to PCM_SYNC.

PCM Timing Data – Master Mode

Symbol	Min.	Typ.	Max.	Unit
F _{BCLK}		2/2.048		MHz
Duty Cycle _{BCLK}	0.4	0.5	0.6	
T _{BCLK rise/fall}		3		ns
T _{DO}			15	ns
T _{DISU}	20			ns
T _{DIHO}	15			ns
T _{BF}			15	ns

PCM Timing Diagram – Master Mode

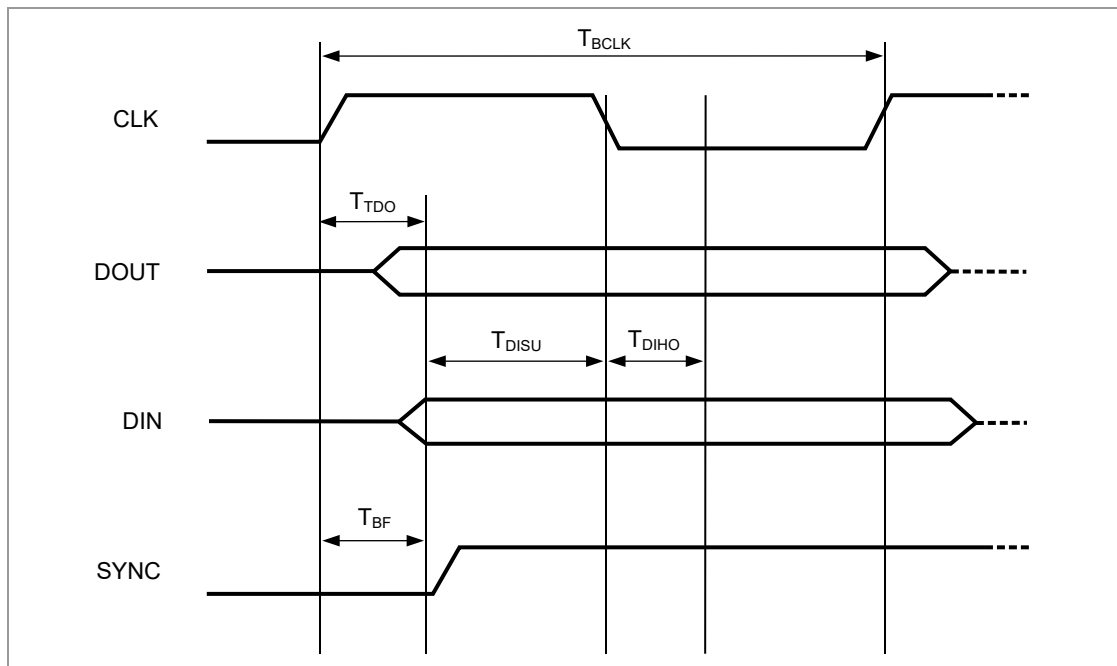

PCM Timing Data – Slave Mode

Symbol	Min.	Typ.	Max.	Unit
F_{BCLK}		2/2.048		MHz
Duty Cycle _{BCLK}	0.4	0.5	0.6	
$T_{BCLK\ rise/fall}$		3		ns
T_{DO}			30	ns
T_{DISU}	15			ns
T_{DIHO}	10			ns
T_{BFSU}	15			ns
T_{BFHO}	10			

PCM Timing Diagram – Slave Mode

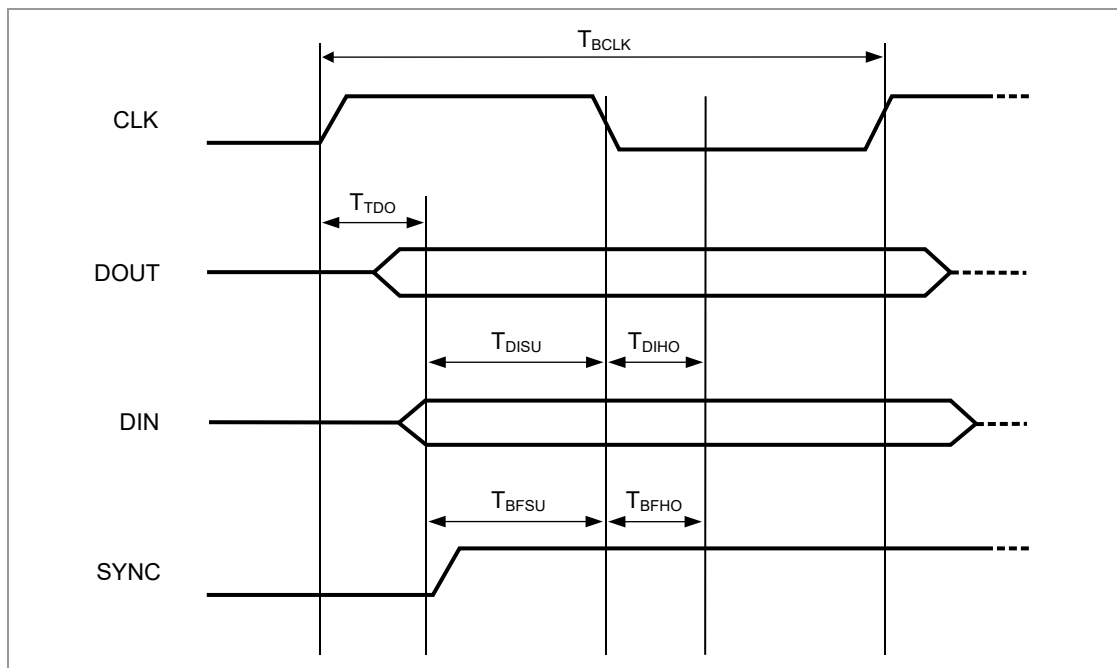

4.10.4 Coexistence Interface



The Peripheral Interface pins are powered from the V_{IO} voltage supply with 3.3 V or 1.8 V.

For DC specifications please refer to “Digital Pin Characteristics” ⇨ [4.3 Recommended Operating Conditions](#).

4.11 RF Electrical Characteristics

4.11.1 WLAN Radio Specification

Receive Mode

Parameter	Condition	Min.	Typ.	Max.	Unit
RF frequency range	2.4 GHz – IEEE 802.11b/g/n	2 400		2 500	MHz
	5 GHz – IEEE 802.11a/n/ac	4 900		5 925	MHz

Transmit Mode

Parameter	Condition	Min.	Typ.	Max.	Unit
RF frequency range	2.4 GHz – IEEE 802.11b/g/n	2 400		2 500	MHz
	5 GHz – IEEE 802.11a/n/ac	4 900		5 925	MHz

4.11.2 WLAN RF Characteristics

4.11.2.1 RF Characteristics for IEEE 802.11b



For module variant ENWF940[x]A1EF assume $V_{DD3V3} = 3.3\text{ V}$, $V_{I0SD} = 3.3\text{ V}$, $V_{I0} = 3.3\text{ V}$ and $T_{amb} = 25\text{ °C}$, if nothing else stated.

For module variant ENWF940[x]A2EF assume $V_{DD3V3} = 3.3\text{ V}$, $V_{DD2V2} = 2.2\text{ V}$, $V_{DD1V8} = 1.8\text{ V}$, $V_{DD1V1} = 1.1\text{ V}$, $V_{I0SD} = 3.3\text{ V}$, $V_{I0} = 3.3\text{ V}$ and $T_{amb} = 25\text{ °C}$, if nothing else stated.

50 Ω terminal load connected to the RF connector.

Parameter	Condition	Min.	Typ.	Max.	Unit
RF frequency range		2 400		2 483.5	MHz
Carrier frequency tolerance		-25		+25	ppm
Transmit output power			+16		dBm
Spectrum mask	$f_c \pm 11\text{ MHz}$			-30	dBr
	$f_c \pm 22\text{ MHz}$			-50	dBr
Power-on/Power-down ramp				2	μs
RF Carrier suppression				-15	dB
Error Vector Magnitude (EVM)	Peak			35	%
Minimum receive sensitivity	1 Mbps (DSSS)	$FER \leq 8\%$		-97	dBm
	2 Mbps (DSSS)	$FER \leq 8\%$		-93	dBm
	5.5 Mbps (CCK)	$FER \leq 8\%$		-91	dBm
	11 Mbps (CCK)	$FER \leq 8\%$		-88	dBm
Maximum input level		$FER \leq 8\%$		-10	dBm
Adjacent channel rejection		$FER \leq 8\%$	35		dB

4.11.2.2 RF Characteristics for IEEE 802.11g



For module variant ENWF940[x]A1EF assume $V_{DD3V3} = 3.3\text{ V}$, $V_{I0SD} = 3.3\text{ V}$, $V_{I0} = 3.3\text{ V}$ and $T_{amb} = 25\text{ }^{\circ}\text{C}$, if nothing else stated.

For module variant ENWF940[x]A2EF assume $V_{DD3V3} = 3.3\text{ V}$, $V_{DD2V2} = 2.2\text{ V}$, $V_{DD1V8} = 1.8\text{ V}$, $V_{DD1V1} = 1.1\text{ V}$, $V_{I0SD} = 3.3\text{ V}$, $V_{I0} = 3.3\text{ V}$ and $T_{amb} = 25\text{ }^{\circ}\text{C}$, if nothing else stated.

50 Ω terminal load connected to the RF connector.

Parameter	Condition	Min.	Typ.	Max.	Unit
RF frequency range	2.4 GHz	2 400		2 483.5	MHz
Carrier frequency tolerance		-25		+25	ppm
Transmit output power	6 Mbps ~ 36 Mbps		+16		dBm
	48 Mbps ~ 54 Mbps		+16		dBm
Spectrum mask	$f_c \pm 11\text{ MHz}$			-20	dBr
	$f_c \pm 20\text{ MHz}$			-28	dBr
	$f_c \pm 30\text{ MHz}$			-40	dBr
Transmitter center frequency leakage				-15	dB
Transmitter Spectral Flatness		-4		+4	dB
EVM Constellation Error (EVM)	BPSK, CR 1/2 (6 Mbps)			-5	dB
	BPSK, CR 3/4 (9 Mbps)			-8	dB
	QPSK, CR 1/2 (12 Mbps)			-10	dB
	QPSK, CR 3/4 (18 Mbps)			-13	dB
	16-QAM, CR 1/2 (24 Mbps)			-16	dB
	16-QAM, CR 3/4 (36 Mbps)			-19	dB
	64-QAM, CR 2/3 (48 Mbps)			-22	dB
	64-QAM, CR 3/4 (54 Mbps)			-25	dB
Minimum receive sensitivity	BPSK, CR 1/2 (6 Mbps)	PER $\leq 10\%$	-89	-82	dBm
	BPSK, CR 3/4 (9 Mbps)	PER $\leq 10\%$	-89	-81	dBm
	QPSK, CR 1/2 (12 Mbps)	PER $\leq 10\%$	-88	-79	dBm
	QPSK, CR 3/4 (18 Mbps)	PER $\leq 10\%$	-86	-77	dBm
	16-QAM, CR 1/2 (24 Mbps)	PER $\leq 10\%$	-83	-74	dBm
	16-QAM, CR 3/4 (36 Mbps)	PER $\leq 10\%$	-80	-70	dBm
	64-QAM, CR 2/3 (48 Mbps)	PER $\leq 10\%$	-76	-66	dBm
	64-QAM, CR 3/4 (54 Mbps)	PER $\leq 10\%$	-74	-65	dBm
Maximum input level	PER $\leq 10\%$			-20	dBm
Adjacent channel rejection	PER $\leq 10\%$	16			dB
	PER $\leq 10\%$	-1			dB

4.11.2.3 RF Characteristics for IEEE 802.11n (BW 20 MHz, 2.4 GHz)



For module variant ENWF940[x]A1EF assume $V_{DD3V3} = 3.3\text{ V}$, $V_{IO} = 3.3\text{ V}$, $V_{IO} = 3.3\text{ V}$ and $T_{amb} = 25\text{ }^{\circ}\text{C}$, if nothing else stated.

For module variant ENWF940[x]A2EF assume $V_{DD3V3} = 3.3\text{ V}$, $V_{DD2V2} = 2.2\text{ V}$, $V_{DD1V8} = 1.8\text{ V}$, $V_{DD1V1} = 1.1\text{ V}$, $V_{IO} = 3.3\text{ V}$, $V_{IO} = 3.3\text{ V}$ and $T_{amb} = 25\text{ }^{\circ}\text{C}$, if nothing else stated.

50 Ω terminal load connected to the RF connector.

Parameter	Condition	Min.	Typ.	Max.	Unit	
RF frequency range	2.4 GHz	2 400		2 483.5	MHz	
Carrier frequency tolerance		-25		+25	ppm	
Transmit output power	MCS0 ~ MCS2		+16		dBm	
	MCS3 ~ MCS4		+16		dBm	
	MCS5 ~ MCS7		+16		dBm	
Spectrum mask	$f_c \pm 11\text{ MHz}$			-20	dBr	
	$f_c \pm 20\text{ MHz}$			-28	dBr	
	$f_c \pm 30\text{ MHz}$			-45	dBr	
Transmitter center frequency leakage				-15	dB	
Transmitter spectral flatness		-4		+4	dB	
Constellation Error (EVM)	BPSK, CR 1/2 (MCS0)			-5	dB	
	QPSK, CR 1/2 (MCS1)			-10	dB	
	QPSK, CR 3/4 (MCS2)			-13	dB	
	16-QAM, CR 1/2 (MCS3)			-16	dB	
	16-QAM, CR 3/4 (MCS4)			-19	dB	
	64-QAM, CR 2/3 (MCS5)			-22	dB	
	64-QAM, CR 3/4 (MCS6)			-25	dB	
	64-QAM, CR 5/6 (MCS7)			-27	dB	
Minimum receive sensitivity ¹⁷	6.5 Mbps (MCS0)	PER \leq 10 %		-89	-82	dBm
	13 Mbps (MCS1)	PER \leq 10 %		-87	-79	dBm
	19.5 Mbps (MCS2)	PER \leq 10 %		-84	-77	dBm
	26 Mbps (MCS3)	PER \leq 10 %		-81	-74	dBm
	39 Mbps (MCS4)	PER \leq 10 %		-78	-70	dBm
	52 Mbps (MCS5)	PER \leq 10 %		-75	-66	dBm
	58.5 Mbps (MCS6)	PER \leq 10 %		-73	-65	dBm
	65 Mbps (MCS7)	PER \leq 10 %		-71	-64	dBm

¹⁷ The minimum sensitivity levels apply only to non-STBC modes, MCS 0~7, 800 ns LGI, and BCC.

Parameter	Condition	Min.	Typ.	Max.	Unit
Maximum input level	PER ≤ 10 %			-20	dBm
Adjacent channel rejection ¹⁸	65 Mbps (MCS7)	PER ≤ 10 %	-2		dB

4.11.2.4 RF Characteristics for IEEE 802.11n (BW 40 MHz, 2.4 GHz)



For module variant ENWF940[x]A1EF assume $V_{DD3V3} = 3.3\text{ V}$, $V_{IO\text{SD}} = 3.3\text{ V}$, $V_{IO} = 3.3\text{ V}$ and $T_{\text{amb}} = 25\text{ °C}$, if nothing else stated.

For module variant ENWF940[x]A2EF assume $V_{DD3V3} = 3.3\text{ V}$, $V_{DD2V2} = 2.2\text{ V}$, $V_{DD1V8} = 1.8\text{ V}$, $V_{DD1V1} = 1.1\text{ V}$, $V_{IO\text{SD}} = 3.3\text{ V}$, $V_{IO} = 3.3\text{ V}$ and $T_{\text{amb}} = 25\text{ °C}$, if nothing else stated.

50 Ω terminal load connected to the RF connector.

Parameter	Condition	Min.	Typ.	Max.	Unit
RF frequency range	2.4 GHz	2 400		2 483.5	MHz
Carrier frequency tolerance		-25		+25	ppm
Transmit output power	MCS0 ~ MCS2		+14		dBm
	MCS3 ~ MCS4		+14		dBm
	MCS5 ~ MCS7		+13		dBm
Spectrum mask	$f_c \pm 21\text{ MHz}$			-20	dBr
	$f_c \pm 40\text{ MHz}$			-28	dBr
	$f_c \pm 60\text{ MHz}$			-45	dBr
Transmitter center frequency leakage				-20	dB
Transmitter spectral flatness		-4		+4	dB
Constellation Error (EVM)	BPSK, CR 1/2 (MCS0)			-5	dB
	QPSK, CR 1/2 (MCS1)			-10	dB
	QPSK, CR 3/4 (MCS2)			-13	dB
	16-QAM, CR 1/2 (MCS3)			-16	dB
	16-QAM, CR 3/4 (MCS4)			-19	dB
	64-QAM, CR 2/3 (MCS5)			-22	dB
	64-QAM, CR 3/4 (MCS6)			-25	dB
Minimum receive sensitivity ¹⁷	13.5 Mbps (MCS0)	PER ≤ 10 %	-83	-79	dBm
	27 Mbps (MCS1)	PER ≤ 10 %	-83	-76	dBm
	40.5 Mbps (MCS2)	PER ≤ 10 %	-80	-74	dBm
	54 Mbps (MCS3)	PER ≤ 10 %	-78	-71	dBm
	81 Mbps (MCS4)	PER ≤ 10 %	-73	-67	dBm

¹⁸ The adjacent channel rejection levels apply only to non-STBC modes, MCS 0~7, 800 ns LGI, and BCC.

Parameter	Condition	Min.	Typ.	Max.	Unit	
	108 Mbps (MCS5)	PER ≤ 10 %		-70	-63	dBm
	121.5 Mbps (MCS6)	PER ≤ 10 %		-68	-62	dBm
	135 Mbps (MCS7)	PER ≤ 10 %		-66	-61	dBm
Maximum input level		PER ≤ 10 %			-20	dBm
Adjacent channel rejection ¹⁸	135 Mbps (MCS7)	PER ≤ 10 %	-2			dB

4.11.2.5 RF Characteristics for IEEE 802.11n (BW 20 MHz, 5 GHz)



For module variant ENWF940[x]A1EF assume $V_{DD3V3} = 3.3\text{ V}$, $V_{IO\text{SD}} = 3.3\text{ V}$, $V_{IO} = 3.3\text{ V}$ and $T_{\text{amb}} = 25\text{ °C}$, if nothing else stated.

For module variant ENWF940[x]A2EF assume $V_{DD3V3} = 3.3\text{ V}$, $V_{DD2V2} = 2.2\text{ V}$, $V_{DD1V8} = 1.8\text{ V}$, $V_{DD1V1} = 1.1\text{ V}$, $V_{IO\text{SD}} = 3.3\text{ V}$, $V_{IO} = 3.3\text{ V}$ and $T_{\text{amb}} = 25\text{ °C}$, if nothing else stated.

50 Ω terminal load connected to the RF connector.

Parameter	Condition	Min.	Typ.	Max.	Unit	
RF frequency range	5 GHz U-NII-1		5 150		5 250	MHz
	5 GHz U-NII-2A		5 250		5 350	MHz
	5 GHz U-NII-2C		5 470		5 725	MHz
	5 GHz U-NII-3		5 725		5 825	MHz
Carrier frequency tolerance		-20		+20	ppm	
Transmit output power	MCS0 ~ MCS2			+16		dBm
	MCS3 ~ MCS4			+16		dBm
	MCS5 ~ MCS7			+15		dBm
Spectrum mask	$f_c \pm 11\text{ MHz}$				-20	dBr
	$f_c \pm 20\text{ MHz}$				-28	dBr
	$f_c \pm 30\text{ MHz}$				-40	dBr
Transmitter center frequency leakage					-15	dB
Transmitter spectral flatness			-4		+4	dB
Constellation Error (EVM)	BPSK, CR 1/2 (MCS0)				-5	dB
	QPSK, CR 1/2 (MCS1)				-10	dB
	QPSK, CR 3/4 (MCS2)				-13	dB
	16-QAM, CR 1/2 (MCS3)				-16	dB
	16-QAM, CR 3/4 (MCS4)				-19	dB
	64-QAM, CR 2/3 (MCS5)				-22	dB
	64-QAM, CR 3/4 (MCS6)				-25	dB
	64-QAM, CR 5/6 (MCS7)				-27	dB

Parameter	Condition	Min.	Typ.	Max.	Unit	
Minimum receive sensitivity ¹⁷	6.5 Mbps (MCS0)	PER ≤ 10 %		-90	-82	dBm
	13 Mbps (MCS1)	PER ≤ 10 %		-87	-79	dBm
	19.5 Mbps (MCS2)	PER ≤ 10 %		-85	-77	dBm
	26 Mbps (MCS3)	PER ≤ 10 %		-82	-74	dBm
	39 Mbps (MCS4)	PER ≤ 10 %		-80	-70	dBm
	52 Mbps (MCS5)	PER ≤ 10 %		-75	-66	dBm
	58.5 Mbps (MCS6)	PER ≤ 10 %		-74	-65	dBm
	65 Mbps (MCS7)	PER ≤ 10 %		-72	-64	dBm
Maximum input level	PER ≤ 10 %			-30	dBm	
Adjacent channel rejection ¹⁸	65 Mbps (MCS7)	PER ≤ 10 %	-2		dB	

4.11.2.6 RF Characteristics for IEEE 802.11n (BW 40 MHz, 5 GHz)



For module variant ENWF940[x]A1EF assume $V_{DD3V3} = 3.3\text{ V}$, $V_{I0SD} = 3.3\text{ V}$, $V_{I0} = 3.3\text{ V}$ and $T_{amb} = 25\text{ °C}$, if nothing else stated.

For module variant ENWF940[x]A2EF assume $V_{DD3V3} = 3.3\text{ V}$, $V_{DD2V2} = 2.2\text{ V}$, $V_{DD1V8} = 1.8\text{ V}$, $V_{DD1V1} = 1.1\text{ V}$, $V_{I0SD} = 3.3\text{ V}$, $V_{I0} = 3.3\text{ V}$ and $T_{amb} = 25\text{ °C}$, if nothing else stated.

50 Ω terminal load connected to the RF connector.

Parameter	Condition	Min.	Typ.	Max.	Unit	
RF frequency range	5 GHz U-NII-1		5 150		5 250	MHz
	5 GHz U-NII-2A		5 250		5 350	MHz
	5 GHz U-NII-2C		5 470		5 725	MHz
	5 GHz U-NII-3		5 725		5 825	MHz
Carrier frequency tolerance		-20		+20	ppm	
Transmit output power	MCS0 ~ MCS2			+16		dBm
	MCS3 ~ MCS4			+16		dBm
	MCS5 ~ MCS7			+15		dBm
Spectrum mask	$f_c \pm 21\text{ MHz}$				-20	dBr
	$f_c \pm 40\text{ MHz}$				-28	dBr
	$f_c \pm 60\text{ MHz}$				-40	dBr
Transmitter center frequency leakage				-20	dB	
Transmitter spectral flatness		-4		+4	dB	
Constellation Error (EVM)	BPSK, CR 1/2 (MCS0)				-5	dB
	QPSK, CR 1/2 (MCS1)				-10	dB
	QPSK, CR 3/4 (MCS2)				-13	dB
	16-QAM, CR 1/2 (MCS3)				-16	dB

Parameter		Condition	Min.	Typ.	Max.	Unit
	16-QAM, CR 3/4 (MCS4)				-19	dB
	64-QAM, CR 2/3 (MCS5)				-22	dB
	64-QAM, CR 3/4 (MCS6)				-25	dB
	64-QAM, CR 5/6 (MCS7)				-27	dB
Minimum receive sensitivity ¹⁷	13.5 Mbps (MCS0)	PER ≤ 10 %		-87	-79	dBm
	27 Mbps (MCS1)	PER ≤ 10 %		-84	-76	dBm
	40.5 Mbps (MCS2)	PER ≤ 10 %		-82	-74	dBm
	54 Mbps (MCS3)	PER ≤ 10 %		-79	-71	dBm
	81 Mbps (MCS4)	PER ≤ 10 %		-77	-67	dBm
	108 Mbps (MCS5)	PER ≤ 10 %		-73	-63	dBm
	121.5 Mbps (MCS6)	PER ≤ 10 %		-71	-62	dBm
	135 Mbps (MCS7)	PER ≤ 10 %		-70	-61	dBm
Maximum input level		PER ≤ 10 %			-30	dBm
Adjacent channel rejection ¹⁸	135 Mbps (MCS7)	PER ≤ 10 %	-2			dB

4.11.2.7 RF Characteristics for IEEE 802.11ac (BW 20 MHz)



For module variant ENWF940[x]A1EF assume $V_{DD3V3} = 3.3\text{ V}$, $V_{IO\text{SD}} = 3.3\text{ V}$, $V_{IO} = 3.3\text{ V}$ and $T_{\text{amb}} = 25\text{ }^{\circ}\text{C}$, if nothing else stated.

For module variant ENWF940[x]A2EF assume $V_{DD3V3} = 3.3\text{ V}$, $V_{DD2V2} = 2.2\text{ V}$, $V_{DD1V8} = 1.8\text{ V}$, $V_{DD1V1} = 1.1\text{ V}$, $V_{IO\text{SD}} = 3.3\text{ V}$, $V_{IO} = 3.3\text{ V}$ and $T_{\text{amb}} = 25\text{ }^{\circ}\text{C}$, if nothing else stated.

50 Ω terminal load connected to the RF connector.

Parameter		Condition	Min.	Typ.	Max.	Unit
RF frequency range	5 GHz U-NII-1		5 150		5 250	MHz
	5 GHz U-NII-2A		5 250		5 350	MHz
	5 GHz U-NII-2C		5 470		5 725	MHz
	5 GHz U-NII-3		5 725		5 825	MHz
Carrier frequency tolerance			-20		+20	ppm
Transmit output power	MCS0 ~ MCS2			+16		dBm
	MCS3 ~ MCS4			+16		dBm
	MCS5 ~ MCS7			+15		dBm
	MCS8			+12		dBm
Spectrum mask	$f_c \pm 11\text{ MHz}$				-20	dBr
	$f_c \pm 20\text{ MHz}$				-28	dBr
	$f_c \pm 30\text{ MHz}$				-40	dBr
Transmitter center frequency leakage	P is transmit power per antenna in dBm				P-17.48	dB

Parameter	Condition	Min.	Typ.	Max.	Unit	
Transmitter spectral flatness		-4		+4	dB	
Constellation Error (EVM)	BPSK, CR 1/2 (MCS0)			-5	dB	
	QPSK, CR 1/2 (MCS1)			-10	dB	
	QPSK, CR 3/4 (MCS2)			-13	dB	
	16-QAM, CR 1/2 (MCS3)			-16	dB	
	16-QAM, CR 3/4 (MCS4)			-19	dB	
	64-QAM, CR 2/3 (MCS5)			-22	dB	
	64-QAM, CR 3/4 (MCS6)			-25	dB	
	64-QAM, CR 5/6 (MCS7)			-27	dB	
	256-QAM, CR 3/4 (MCS8)			-30	dB	
Minimum receive sensitivity ¹⁷	6.5 Mbps (MCS0)	PER ≤ 10 %		-90	-82	dBm
	13 Mbps (MCS1)	PER ≤ 10 %		-87	-79	dBm
	19.5 Mbps (MCS2)	PER ≤ 10 %		-85	-77	dBm
	26 Mbps (MCS3)	PER ≤ 10 %		-82	-74	dBm
	39 Mbps (MCS4)	PER ≤ 10 %		-80	-70	dBm
	52 Mbps (MCS5)	PER ≤ 10 %		-75	-66	dBm
	58.5 Mbps (MCS6)	PER ≤ 10 %		-74	-65	dBm
	65 Mbps (MCS7)	PER ≤ 10 %		-72	-64	dBm
	78 Mbps (MCS8)	PER ≤ 10 %		-68	-59	dBm
Maximum input level	PER ≤ 10 %			-30	dBm	
Adjacent channel rejection ¹⁸	78 Mbps (MCS8)	PER ≤ 10 %	-7		dB	

4.11.2.8 RF Characteristics for IEEE 802.11ac (BW 40 MHz)



For module variant ENWF940[x]A1EF assume $V_{DD3V3} = 3.3\text{ V}$, $V_{IO\text{SD}} = 3.3\text{ V}$, $V_{IO} = 3.3\text{ V}$ and $T_{\text{amb}} = 25\text{ °C}$, if nothing else stated.

For module variant ENWF940[x]A2EF assume $V_{DD3V3} = 3.3\text{ V}$, $V_{DD2V2} = 2.2\text{ V}$, $V_{DD1V8} = 1.8\text{ V}$, $V_{DD1V1} = 1.1\text{ V}$, $V_{IO\text{SD}} = 3.3\text{ V}$, $V_{IO} = 3.3\text{ V}$ and $T_{\text{amb}} = 25\text{ °C}$, if nothing else stated.

50 Ω terminal load connected to the RF connector.

Parameter	Condition	Min.	Typ.	Max.	Unit
RF frequency range	5 GHz U-NII-1	5 150		5 250	MHz
	5 GHz U-NII-2A	5 250		5 350	MHz
	5 GHz U-NII-2C	5 470		5 725	MHz
	5 GHz U-NII-3	5 725		5 825	MHz
Carrier frequency tolerance		-20		+20	ppm

Parameter	Condition	Min.	Typ.	Max.	Unit
Transmit output power	MCS0 ~ MCS2		+16		dBm
	MCS3 ~ MCS4		+16		dBm
	MCS5 ~ MCS7		+15		dBm
	MCS8 ~ MCS9		+11		dBm
Spectrum mask	$f_c \pm 21$ MHz			-20	dBr
	$f_c \pm 40$ MHz			-28	dBr
	$f_c \pm 60$ MHz			-40	dBr
Transmitter center frequency leakage	P is transmit power per antenna in dBm			P-20.57	dB
Transmitter spectral flatness		-4		+4	dB
Constellation Error (EVM)	BPSK, CR 1/2 (MCS0)			-5	dB
	QPSK, CR 1/2 (MCS1)			-10	dB
	QPSK, CR 3/4 (MCS2)			-13	dB
	16-QAM, CR 1/2 (MCS3)			-16	dB
	16-QAM, CR 3/4 (MCS4)			-19	dB
	64-QAM, CR 2/3 (MCS5)			-22	dB
	64-QAM, CR 3/4 (MCS6)			-25	dB
	64-QAM, CR 5/6 (MCS7)			-27	dB
	256-QAM, CR 3/4 (MCS8)			-30	dB
	256-QAM, CR 5/6 (MCS9)			-32	dB
Minimum receive sensitivity ¹⁷	13.5 Mbps (MCS0)	PER ≤ 10 %	-87	-79	dBm
	27 Mbps (MCS1)	PER ≤ 10 %	-84	-76	dBm
	40.5 Mbps (MCS2)	PER ≤ 10 %	-82	-74	dBm
	54 Mbps (MCS3)	PER ≤ 10 %	-79	-71	dBm
	81 Mbps (MCS4)	PER ≤ 10 %	-77	-67	dBm
	108 Mbps (MCS5)	PER ≤ 10 %	-73	-63	dBm
	121.5 Mbps (MCS6)	PER ≤ 10 %	-71	-62	dBm
	135 Mbps (MCS7)	PER ≤ 10 %	-70	-61	dBm
	162 Mbps (MCS8)	PER ≤ 10 %	-65	-56	dBm
	180 Mbps (MCS9)	PER ≤ 10 %	-64	-54	dBm
Maximum input level	PER ≤ 10 %			-30	dBm
Adjacent channel rejection ¹⁸	180 Mbps (MCS9)	PER ≤ 10 %	-9		dB

4.11.2.9 RF Characteristics for IEEE 802.11ac (BW 80 MHz)



For module variant ENWF940[x]A1EF assume $V_{DD3V3} = 3.3\text{ V}$, $V_{IO\text{SD}} = 3.3\text{ V}$, $V_{IO} = 3.3\text{ V}$ and $T_{\text{amb}} = 25\text{ }^{\circ}\text{C}$, if nothing else stated.

For module variant ENWF940[x]A2EF assume $V_{DD3V3} = 3.3\text{ V}$, $V_{DD2V2} = 2.2\text{ V}$, $V_{DD1V8} = 1.8\text{ V}$, $V_{DD1V1} = 1.1\text{ V}$, $V_{IO\text{SD}} = 3.3\text{ V}$, $V_{IO} = 3.3\text{ V}$ and $T_{\text{amb}} = 25\text{ }^{\circ}\text{C}$, if nothing else stated.

50 Ω terminal load connected to the RF connector.

Parameter	Condition	Min.	Typ.	Max.	Unit
RF frequency range	5 GHz U-NII-1	5 150		5 250	MHz
	5 GHz U-NII-2A	5 250		5 350	MHz
	5 GHz U-NII-2C	5 470		5 725	MHz
	5 GHz U-NII-3	5 725		5 825	MHz
Carrier frequency tolerance		-20		+20	ppm
Transmit output power	MCS0 ~ MCS2		+14		dBm
	MCS3 ~ MCS4		+14		dBm
	MCS5 ~ MCS7		+12		dBm
	MCS8 ~ MCS9		+10		dBm
Spectrum mask	$f_c \pm 41\text{ MHz}$			-20	dBr
	$f_c \pm 80\text{ MHz}$			-28	dBr
	$f_c \pm 120\text{ MHz}$			-40	dBr
Transmitter center frequency leakage	P is transmit power per antenna in dBm			P-23.84	dB
Transmitter spectral flatness		-4		+4	dB
Constellation Error (EVM)	BPSK, CR 1/2 (MCS0)			-5	dB
	QPSK, CR 1/2 (MCS1)			-10	dB
	QPSK, CR 3/4 (MCS2)			-13	dB
	16-QAM, CR 1/2 (MCS3)			-16	dB
	16-QAM, CR 3/4 (MCS4)			-19	dB
	64-QAM, CR 2/3 (MCS5)			-22	dB
	64-QAM, CR 3/4 (MCS6)			-25	dB
	64-QAM, CR 5/6 (MCS7)			-27	dB
	256-QAM, CR 3/4 (MCS8)			-30	dB
256-QAM, CR 5/6 (MCS9)			-32	dB	
Minimum receive sensitivity ¹⁷	29.3 Mbps (MCS0)	PER \leq 10 %	-83	-76	dBm
	58.5 Mbps (MCS1)	PER \leq 10 %	-81	-73	dBm
	87.8 Mbps (MCS2)	PER \leq 10 %	-78	-71	dBm
	117 Mbps (MCS3)	PER \leq 10 %	-76	-68	dBm
	175.5 Mbps (MCS4)	PER \leq 10 %	-74	-64	dBm

Parameter		Condition	Min.	Typ.	Max.	Unit
	234 Mbps (MCS5)	PER ≤ 10 %		-69	-60	dBm
	263.3 Mbps (MCS6)	PER ≤ 10 %		-68	-59	dBm
	292.5 Mbps (MCS7)	PER ≤ 10 %		-66	-58	dBm
	351 Mbps (MCS8)	PER ≤ 10 %		-62	-53	dBm
	390 Mbps (MCS9)	PER ≤ 10 %		-59	-51	dBm
Maximum input level		PER ≤ 10 %			-30	dBm
Adjacent channel rejection ¹⁸	390 Mbps (MCS9)	PER ≤ 10 %	-9			dB

4.11.2.10 RF Characteristics for IEEE 802.11a



For module variant ENWF940[x]A1EF assume $V_{DD3V3} = 3.3\text{ V}$, $V_{I0SD} = 3.3\text{ V}$, $V_{I0} = 3.3\text{ V}$ and $T_{amb} = 25\text{ °C}$, if nothing else stated.

For module variant ENWF940[x]A2EF assume $V_{DD3V3} = 3.3\text{ V}$, $V_{DD2V2} = 2.2\text{ V}$, $V_{DD1V8} = 1.8\text{ V}$, $V_{DD1V1} = 1.1\text{ V}$, $V_{I0SD} = 3.3\text{ V}$, $V_{I0} = 3.3\text{ V}$ and $T_{amb} = 25\text{ °C}$, if nothing else stated.

50 Ω terminal load connected to the RF connector.

Parameter		Condition	Min.	Typ.	Max.	Unit
RF frequency range	5 GHz U-NII-1		5 150		5 250	MHz
	5 GHz U-NII-2A		5 250		5 350	MHz
	5 GHz U-NII-2C		5 470		5 725	MHz
	5 GHz U-NII-3		5 725		5 825	MHz
Carrier frequency tolerance			-20		+20	Ppm
Transmit output power	6 Mbps ~ 36 Mbps			+16		dBm
	48 Mbps ~ 54 Mbps			+16		dBm
Spectrum mask	$f_c \pm 11\text{ MHz}$				-20	dBr
	$f_c \pm 20\text{ MHz}$				-28	dBr
	$f_c \pm 30\text{ MHz}$				-40	dBr
Transmitter center frequency leakage					-15	dB
Transmitter spectral flatness			-4		+4	dB
Constellation Error (EVM)	BPSK, CR 1/2 (6 Mbps)				-5	dB
	BPSK, CR 3/4 (9 Mbps)				-8	dB
	QPSK, CR 1/2 (12 Mbps)				-10	dB
	QPSK, CR 3/4 (18 Mbps)				-13	dB
	16-QAM, CR 1/2 (24 Mbps)				-16	dB
	16-QAM, CR 3/4 (36 Mbps)				-19	dB
	64-QAM, CR 2/3 (48 Mbps)				-22	dB
64-QAM, CR 3/4 (54 Mbps)				-25	dB	

Parameter		Condition	Min.	Typ.	Max.	Unit
Minimum receive sensitivity	BPSK, CR 1/2 (6 Mbps)	PER ≤ 10 %		-90	-82	dBm
	BPSK, CR 3/4 (9 Mbps)	PER ≤ 10 %		-90	-79	dBm
	QPSK, CR 1/2 (12 Mbps)	PER ≤ 10 %		-89	-77	dBm
	QPSK, CR 3/4 (18 Mbps)	PER ≤ 10 %		-87	-74	dBm
	16-QAM, CR 1/2 (24 Mbps)	PER ≤ 10 %		-85	-70	dBm
	16-QAM, CR 3/4 (36 Mbps)	PER ≤ 10 %		-81	-66	dBm
	64-QAM, CR 2/3 (48 Mbps)	PER ≤ 10 %		-77	-65	dBm
	64-QAM, CR 3/4 (54 Mbps)	PER ≤ 10 %		-75	-64	dBm
Maximum input level		PER ≤ 10 %			-30	dBm
Adjacent channel rejection	BPSK, CR 1/2 (6 Mbps)	PER ≤ 10 %	16			dB
	64-QAM, CR 3/4 (54 Mbps)	PER ≤ 10 %	-1			dB

4.11.3 Bluetooth RF Characteristics



For module variant ENWF940[x]A1EF assume $V_{DD3V3} = 3.3\text{ V}$, $V_{IO\text{SD}} = 3.3\text{ V}$, $V_{IO} = 3.3\text{ V}$ and $T_{\text{amb}} = 25\text{ }^{\circ}\text{C}$, if nothing else stated.

For module variant ENWF940[x]A2EF assume $V_{DD3V3} = 3.3\text{ V}$, $V_{DD2V2} = 2.2\text{ V}$, $V_{DD1V8} = 1.8\text{ V}$, $V_{DD1V1} = 1.1\text{ V}$, $V_{IO\text{SD}} = 3.3\text{ V}$, $V_{IO} = 3.3\text{ V}$ and $T_{\text{amb}} = 25\text{ }^{\circ}\text{C}$, if nothing else stated.

50 Ω terminal load connected to the RF connector.

4.11.3.1 Receiver Section RF Characteristics

Parameter	Condition		Min.	Typ.	Max.	Unit
RF frequency range			2 400		2 483.5	MHz
Interference Performance (Basic Rate)	GFSK	C/I (Co-channel)			11	dB
		C/I (1 MHz)			0	dB
C/I Ratio	RSL = -67 dBm BER ≤ 0.1 %	C/I (2 MHz)			-30	dB
		C/I (3 MHz)			-40	dB
		C/I (Image)			-9	dB
		C/I (Image ± 1 MHz)			-20	dB

Parameter	Condition		Min.	Typ.	Max.	Unit		
Interference Performance (Enhanced Data Rate) C/I Ratio	$\pi/4$ -DQPSK RSL = -67 dBm BER \leq 0.01 %	C/I (Co-channel)			13	dB		
		C/I (1 MHz)			0	dB		
		C/I (2 MHz)			-30	dB		
		C/I (3 MHz)			-40	dB		
		C/I (Image)			-7	dB		
		C/I (Image \pm 1 MHz)			-20	dB		
	8-DPSK RSL = -67 dBm BER \leq 0.01 %	C/I (Co-channel)			21	dB		
		C/I (1 MHz)			5	dB		
		C/I (2 MHz)			-25	dB		
		C/I (3 MHz)			-33	dB		
		C/I (Image)			0	dB		
		C/I (Image \pm 1 MHz)			-13	dB		
		Interference Performance (Low Energy) C/I Ratio	GFSK RSL = -67 dBm BER \leq 0.1 %	C/I (Co-channel)			21	dB
				C/I (1 MHz)			15	dB
C/I (2 MHz)					-17	dB		
C/I (3 MHz)					-27	dB		
C/I (Image)					-9	dB		
1 Mbps	C/I (Image \pm 1 MHz)				-15	dB		
	GFSK RSL = -67 dBm BER \leq 0.1 %		C/I (Co-channel)			21	dB	
			C/I (2 MHz)			15	dB	
			C/I (3 MHz)			-17	dB	
			C/I (6 MHz)			-27	dB	
C/I (Image)				-9	dB			
2 Mbps	C/I (Image \pm 2 MHz)			-15	dB			
	Minimum Receive Sensitivity	BR, DH1	BER \leq 0.1 %		-94	-70	dBm	
EDR, 2DH1		BER \leq 0.01 %		-90	-70	dBm		
LE, GFSK		BER \leq 0.1 %		-90	-70	dBm		
Out-of-band blocking (Basic Rate) Interfering Signal Power	GFSK RSL = -67 dBm BER \leq 0.1 %	30 MHz to 2 000 MHz			-10	dB		
		2 GHz to 2.399 GHz			-27	dB		
		2.484 GHz to 3 GHz			-27	dB		
		3 GHz to 12.75 GHz			-10	dB		
Out-of-band blocking (Low Energy) Interfering Signal Power	GFSK RSL = -67 dBm BER \leq 0.1 %	30 MHz to 2 000 MHz			-30	dB		
		2 GHz to 2.399 GHz			-35	dB		
		2.484 GHz to 3 GHz			-35	dB		
		3 GHz to 12.75 GHz			-30	dB		
RSSI Range	Resolution = 1 dB			-90	0	dB		

4.11.3.2 Transmitter Section RF Characteristics

Parameter	Condition	Min.	Typ.	Max.	Unit	
RF frequency range		2 400		2 483.5	MHz	
Maximum output power	Basic Rate (BR)		+4		dBm	
	Enhanced Data Rate (EDR)		+4		dBm	
	Low energy (LE)		+4		dBm	
Gain range	Gain Control		30		dB	
Gain resolution			0.5		dB	
Spurious emission (BR) (in-band)	± 500 kHz			-20	dBc	
	± 2 MHz, M-N = 2			-20	dBm	
	± 3 MHz or greater, M-N ≥ 3			-40	dBm	
Spurious emission (EDR) (in-band)	± 1 MHz			-26	dBc	
	± 1.5 MHz			-20	dBm	
	± 2.5 MHz			-40	dBm	
Spurious emission (LE) (in-band)	1 Mbps	± 2 MHz, M-N = 2			-20	dBm
		± 3 MHz or greater, M-N ≥ 3			-30	dBm
	2 Mbps	± 4 MHz, M-N = 4			-20	dBm
		± 5 MHz, M-N = 5			-20	dBm
		± 6 MHz or greater, M-N ≥ 6			-30	dBm

4.12 Reliability Tests

The measurement should be done after the test module has been exposed to room temperature and humidity for one hour.

No.	Item	Limit	Condition		
			Parameter	Value	Unit
1	Variable Vibration Frequency Test (VVF)	Electrical parameters should be within specification	Frequency	20 to 2 000	Hz
			Acceleration	17 to 50	G
			Sweep time	8	min
			Duration/axis	2	h
			Total axis	XYZ	
2	Drop Test (DT)		Drop height	100	cm
			Drop surface	Concrete	
			Sides	6	
			Drop/side	3 times	
3	Temperature Cycling Test (TC)		Temperature	-40 and 85	°C
			Duration/Cycle	1	h
			Total Cycles	300	Cycles
4	Temperature Humidity Bias Test (THB)		Temperature	+60	°C
			Relative Humidity	85	%RH
			Duration	300	h
5	Low Temperature Storage Life Test (LTSL)	Temperature	-40	°C	
		Duration	300	h	
6	High Temperature Storage Life Test (HTSL)	Temperature	+85	°C	
		Duration	300	h	

4.13 Recommended Soldering Profile



- Reflow permissible cycles: 2
- Opposite side reflow is prohibited due to module weight
- More than 75 percent of the soldering area shall be coated by solder
- The soldering profiles should be adhered to in order to prevent electrical or mechanical damage
- Soldering profile assumes lead-free soldering

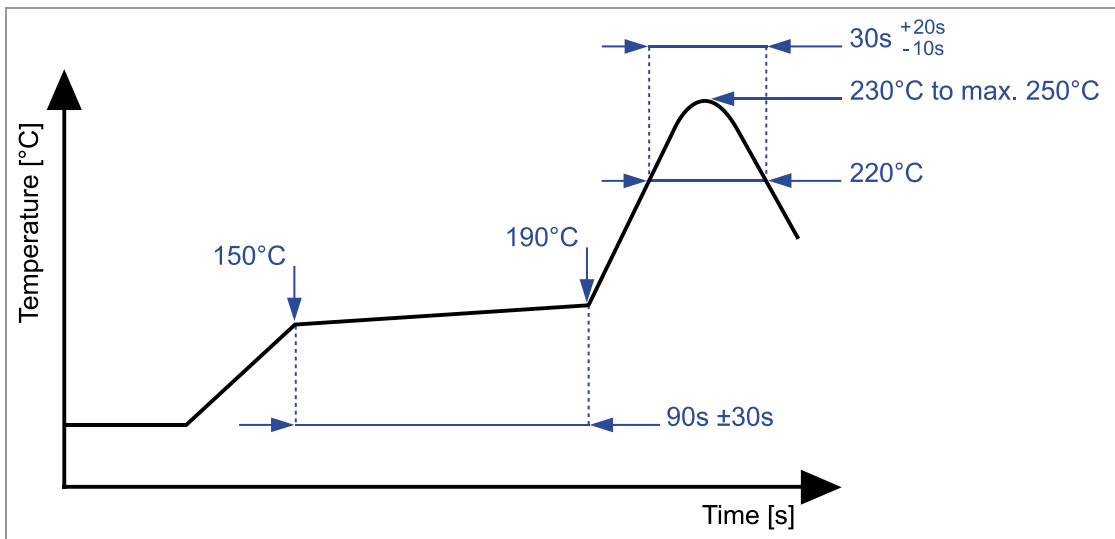

5 Cautions



Failure to follow the guidelines set forth in this document may result in degrading of the module functions and damage to the module.

5.1 Design Notes

1. Follow the conditions written in this specification, especially the control signals of this module.
2. The supply voltage should abide by the maximum ratings (⇒ [4.2 Absolute Maximum Ratings](#)).
3. The supply voltage must be free of AC ripple voltage (for example from a battery or a low noise regulator output). For noisy supply voltages, provide a decoupling circuit (for example a ferrite in series connection and a bypass capacitor to ground of at least 47 μ F directly at the module).
4. This module should not be mechanically stressed when installed.
5. Keep this module away from heat. Heat is the major cause of decreasing the life time of these modules.
6. Avoid assembly and use of the target equipment in conditions where the module temperature may exceed the maximum tolerance.
7. Keep this module away from other high frequency circuits.
8. Refer to the recommended pattern when designing a board.

5.2 Installation Notes

1. Reflow soldering is possible twice based on the conditions set forth in ⇒ [4.13 Recommended Soldering Profile](#). Set up the temperature at the soldering portion of this module according to this reflow profile.
2. Carefully position the module so that the heat will not burn into printed circuit boards or affect other components that are susceptible to heat.
3. Carefully locate the module, to avoid an increased temperature caused by heat generated by neighboring components.
4. If a vinyl-covered wire comes into contact with the module, the wire cover will melt and generate toxic gas, damaging the insulation. Never allow contact between a vinyl cover and these modules to occur.
5. This module should not be mechanically stressed or vibrated when reflowed.
6. To repair the board by hand soldering, follow the conditions set forth in this chapter.
7. Do not wash this product.
8. Pressing on parts of the metal cover or fastening objects to the metal will cause damage to the module.

5.3 Usage Condition Notes

1. Take measures to protect the module against static electricity.
If pulses or transient loads (a large load, which is suddenly applied) are applied to the modules, check and evaluate their operation before assembly of the final products.
2. Do not use dropped modules.
3. Do not touch, damage, or soil the pins.
4. Follow the recommended condition ratings about the power supply applied to this module.
5. Electrode peeling strength: Do not apply a force of more than 4.9 N in any direction on the soldered module.
6. Pressing on parts of the metal cover or fastening objects to the metal cover will cause damage.
7. These modules are intended for general purpose and standard use in general electronic equipment, such as home appliances, office equipment, information, and communication equipment.

5.4 Storage Notes

1. The module should not be stressed mechanically during storage.
2. Do not store these modules in the following conditions or the performance characteristics of the module, such as RF performance will be adversely affected:
 - Storage in salty air or in an environment with a high concentration of corrosive gas, such as Cl₂, H₂S, NH₃, SO₂, or NO_x,
 - Storage in direct sunlight,
 - Storage in an environment where the temperature may be outside the range of 5 °C to 35 °C, or where the humidity may be outside the 45 % to 85 % range,
 - Storage of the modules for more than one year after the date of delivery storage period: Please check the adhesive strength of the embossed tape and soldering after 6 months of storage.
3. Keep this module away from water, poisonous gas, and corrosive gas.
4. This module should not be stressed or shocked when transported.
5. Follow the specification when stacking packed crates (max. 10).

5.5 Safety Cautions

These specifications are intended to preserve the quality assurance of products and individual components.

Before use, check and evaluate the operation when mounted on your products. Abide by these specifications without deviation when using the products. These products may short-circuit. If electrical shocks, smoke, fire, and/or accidents involving human life are anticipated when a short circuit occurs, provide the following failsafe functions as a minimum:

1. Ensure the safety of the whole system by installing a protection circuit and a protection device.
2. Ensure the safety of the whole system by installing a redundant circuit or another system to prevent a single fault causing an unsafe status.

5.6 Other Cautions

1. Do not use the module for other purposes than those listed in section ⇒ [5.3 Usage Condition Notes](#).
2. Be sure to provide an appropriate fail-safe function on your product to prevent any additional damage that may be caused by the abnormal function or the failure of the module.
3. This module has been manufactured without any ozone chemical controlled under the Montreal Protocol.
4. These modules are not intended for use under the special conditions shown below. Before using these modules under such special conditions, carefully check their performance and reliability under the said special conditions to determine whether or not they can be used in such a manner:
 - In liquid, such as water, salt water, oil, alkali, or organic solvent, or in places where liquid may splash,
 - In direct sunlight, outdoors, or in a dusty environment,
 - In an environment where condensation occurs,
 - In an environment with a high concentration of harmful gas (e. g. salty air, HCl, Cl₂, SO₂, H₂S, NH₃, and NO_x).
5. If an abnormal voltage is applied due to a problem occurring in other components or circuits, replace these modules with new modules, because they may not be able to provide normal performance even if their electronic characteristics and appearances appear satisfactory.



For further information please refer to the Panasonic website ⇒ [7.2.2 Product Information](#).

5.7 Restricted Use

5.7.1 Life Support Policy

This Panasonic Industrial Devices Europe GmbH product is not designed for use in life support appliances, devices, or systems where malfunction can reasonably be expected to result in a significant personal injury to the user, or as a critical component in any life support device or system whose failure to perform can be reasonably expected to cause the failure of the life support device or system, or to affect its safety or effectiveness.

Panasonic customers using or selling these products for use in such applications do so at their own risk and agree to fully indemnify Panasonic Industrial Devices Europe GmbH for any damages resulting.

5.7.2 Restricted End Use

This Panasonic Industrial Devices Europe GmbH product is not designed for any restricted activity that supports the development, production, handling usage, maintenance, storage, inventory or proliferation of any weapons or military use.

Transfer, export, re-export, usage or reselling of this product to any destination, end user or any end use prohibited by the European Union, United States or any other applicable law is strictly prohibited.

6 Regulatory and Certification Information

For the device the following certifications are available:

Certification		Status	Reference
FCC	for US	Available	⇒ 6.1 Federal Communications Commission (FCC) for US
ISED	for Canada	Available	⇒ 6.2 Innovation, Science, and Economic Development (ISED) for Canada
RED	for Europe	Available	⇒ 6.3 European Conformity According to RED (2014/53/EU)
UKCA	for United Kingdom	Available	⇒ 6.4 United Kingdom Conformity According to Statutory Instrument SI 2017/1206
MIC	for Japan	Upon request	
SRRC	for China	Upon request	
KCC	for Korea	Upon request	
RCM	for Australia and New Zealand	Upon request	



For regions “upon request”, please reach out to your Sales contact for the most recent status of the certification process ⇒ [7.2.1 Contact Us](#).

6.1 Federal Communications Commission (FCC) for US

6.1.1 FCC Notice



The PAN9028, including the ceramic antenna (model ENWF9408A1EF and model ENWF9408A2EF) and the antennas, which are listed in ⇒ [6.1.5 Approved Antenna List](#), complies with Part 15 of the FCC Rules.

The device meets the requirements for modular transmitter approval as detailed in FCC public Notice DA00-1407. The transmitter operation is subject to the following two conditions:

1. This device may not cause harmful interference, and
2. This device must accept any interference received, including interference that may cause undesired operation.

6.1.2 Caution



The FCC requires the user to be notified that any changes or modifications made to this device that are not expressly approved by Panasonic Industrial Devices Europe GmbH may void the user's authority to operate the equipment.



This equipment has been tested and found to comply with the limits for a Class B digital device, pursuant to Part 15 of the FCC Rules.

These limits are designed to provide reasonable protection against harmful interference in a residential installation. This equipment generates uses and can radiate radio frequency energy and, if not installed and used in accordance with the instructions, may cause harmful interference to radio communications.

There is no guarantee that interference will not occur in a particular installation. If this equipment does cause harmful interference to radio or television reception (which can be determined by turning the equipment off and on) the user is encouraged to try to correct the interference by one or more of the following measures:

- Reorient or relocate the receiving antenna,
- Increase the separation between the equipment and receiver,
- Connect the equipment into an outlet on a circuit different from that to which the receiver is connected,
- Consult the dealer or an experienced radio/TV technician for help.

6.1.3 Label Requirements



The OEM must ensure that FCC labelling requirements are met. This includes a clearly visible label (laser marking) on the outside of the OEM enclosure specifying the appropriate Panasonic FCC identifier for this product as well as the FCC Notice above.

The FCC identifier is **FCC ID: T7V9028**.

This FCC identifier is valid for the PAN9028. The end product must in any case be labelled on the exterior with:

"Contains FCC ID: T7V9028."

Due to the PAN9028 model size, the FCC identifier is displayed in the installation instruction only and it cannot be displayed readable on the module's label due to the limited size.

6.1.4 Antenna Warning

This antenna warning refers to the test device with the model ENWF9408A1EF and ENWF9408A2EF in bottom pad mode (see “PAN9028 Product Specification” ⇒ [7.2.2 Product Information](#)).

The device is tested with a standard SMA connector and with the antenna listed in ⇒ [6.1.5 Approved Antenna List](#). When integrated into an OEM product, these antennas must be fixed to prevent end users from replacing them with non-approved antennas. Any antenna not in the following table must be tested to comply with FCC Section 15.203 for unique antenna connectors and with Section 15.247 for emissions. The FCC identifier for the device with the antenna listed in ⇒ [6.1.5 Approved Antenna List](#) is the same (**FCC ID: T7V9028**).

6.1.5 Approved Antenna List

Item	Part Number	Manufacturer	Type	Polarization	Frequency Band	Gain (dBi)
1	ANT162442DT-2001A2	TDK	Chip antenna	Linear	2.400 GHz to 2.484 GHz	2.1
					5.150 GHz to 5.850 GHz	1.5
2	X9001091-W3DRMW 2016693-x	Kyocera AVX TE Connectivity	Dipole antenna assembly	Linear	2.400 GHz to 2.485 GHz	1.8
					5.150 GHz to 5.850 GHz	2.9
3	X9001091-W3DRMB 2016693-x	Kyocera AVX TE Connectivity	Dipole antenna assembly	Linear	2.400 GHz to 2.485 GHz	1.8
					5.150 GHz to 5.850 GHz	2.9

6.1.6 RF Exposure



To comply with FCC RF Exposure requirements, the OEM must ensure that only antennas are installed which are listed in ⇒ [6.1.5 Approved Antenna List](#).

The preceding statement must be included as a “CAUTION” statement in manuals for products operating with the approved antennas in the previous table to alert users on FCC RF Exposure compliance.

Any notification to the end user of installation or removal instructions about the integrated radio module is not allowed.

The radiated output power of the PAN9028 with a mounted ceramic chip antenna (**FCC ID: T7V9028** for model ENWF9408A1EF and model ENWF9408A2EF) are fulfilled for mobile configuration. The installation of the module is restricted to mobile host devices. The PAN9028 shall be used in such a manner that the potential for human contact during normal operation is minimized.

End users may not be provided with the module installation instructions. OEM integrators and end users must be provided with transmitter operating conditions for satisfying RF exposure compliance.

6.1.7 Integration Instructions

This chapter gives integration instructions for host product manufacturers according to “KDB 996369 D03 OEM Manual v01”.

Section	Topic and Comment	
2.2	List of applicable FCC rules	
	47 CFR Section	Part 15C
	Frequency Band (MHz)	2 400 to 2 483.5
	Systems	Digital Transmission Systems operating within the 2 400 MHz to 2 483.5 MHz Band
	Reference / Requirement	15.247(a)(2), 15.247(b)(1), 15.207, 15.247(d), 15.247(e)
	Complied Module M/N	ENWF9408A1EF, ENWF9408A2EF
	47 CFR Section	Part 15C
	Frequency Band (MHz)	2 400 to 2 483.5
	Systems	Frequency Hopping Systems operating within the 2 400 MHz to 2 483.5 MHz Band
	Reference / Requirement	15.247(a)(1), 15.247(a)(1)(iii), 15.247(b)(1), 15.207, 15.247(d)
	Complied Module M/N	ENWF9408A1EF, ENWF9408A2EF
	47 CFR Section	Part 15E

	Systems	Unlicensed National Information Infrastructure Devices in the 5 GHz Bands
	Reference Method	KDB 905462 D02 v02
	Reference / Requirement	15E.407(h)(2)
	Complied Module M/N	ENWF9408A1EF, ENWF9408A2EF
2.3	Summarize the specific operational use conditions	
	Please refer to ⇒ 5 Cautions , and ⇒ 5.3 Usage Condition Notes .	
2.4	Limited module procedures	
	Not applicable, the module has a single-modular transmitter approval.	
2.5	Trace antenna designs	
	Not applicable, the module has a ceramic chip antenna. For guidance regarding the PCB layout requirements for module integration refer to the Design Guide ⇒ 7.2.2 Product Information .	
2.6	RF exposure considerations	
	Mobile application, the end customer has to assure that the device has a distance of more than 20 cm from the human body under all circumstances.	
2.7	Antennas	
	Please refer to ⇒ 6.1.4 Antenna Warning and ⇒ 6.1.5 Approved Antenna List .	
2.8	Label and compliance information	
	Please refer to ⇒ 6.1.3 Label Requirements .	
2.9	Information on test modes and additional testing requirements	
	The documents for integration guidance and compliance testing are available here ⇒ 7.2.2 Product Information .	
2.10	Additional testing, Part 15 Subpart B disclaimer	
	<p>The single-modular transmitter is FCC authorized for the specific rule parts listed at ⇒ List of applicable FCC rules.</p> <p>The host product manufacturer needs to also consider the FCC requirements for certified modular transmitter being used in the host product and maintain documentation on how the host product with the certified modular transmitter complies with the FCC rules. Host product manufacturers are responsible to follow the integration guidance and to perform a limited set of transmitter module verification testing, to ensure the end product is in compliance with the FCC rules. Also host product manufacturers are responsible for all additional equipment authorization and testing for technical requirements not covered by the module grant (e.g., unintentional radiator Part 15 Subpart B requirements, or transmitters used in the host that are not certified modules).</p>	

6.2 Innovation, Science, and Economic Development (ISED) for Canada

English

The PAN9028 is licensed to meet the regulatory requirements of ISED.

License ID: **IC: 216Q-9028**
HVIN: **ENWF9408A1EF**
ENWF9408A2EF

Manufacturers of mobile, fixed, or portable devices incorporating this module are advised to clarify any regulatory questions and ensure compliance for SAR and/or RF exposure limits. Users can obtain Canadian information on RF exposure and compliance from www.ic.gc.ca.

This device has been designed to operate with the antennas listed in ⇒ [6.1.5 Approved Antenna List](#), having a maximum gain of 2.1 dBi (for 2.4 GHz) and 2.9 dBi (for 5 GHz). Antennas not included in this list or having a gain greater than 2.1 dBi (for 2.4 GHz) and 2.9 dBi (for 5 GHz) are strictly prohibited for use with this device. The required antenna impedance is 50 Ω. The antenna used for this transmitter must not be co-located or operating in conjunction with any other antenna or transmitter.

Due to the model size, the IC identifier is displayed in the installation instruction only and it cannot be displayed on the module's label due to the limited size.



The end customer has to assure that the device has a distance of more than 20 cm from the human body under all circumstances.

If the end customer application intends to use the PAN9028 in a distance smaller 20 cm from the human body, SAR evaluation has to be repeated by the OEM.

The end customer equipment must meet the actual Safety/Health requirements according to ISED.

French

PAN9028 (et ses versions) est garanti conforme aux dispositions réglementaires d'Innovation, Sciences et Développement économique (ISDE).

License: **IC: 216Q-9028**
HVIN: **ENWF9408A1EF**
ENWF9408A2EF

Il est recommandé aux fabricants d'appareils fixes, mobiles ou portables de consulter la réglementation en vigueur et de vérifier la conformité de leurs produits relativement aux limites d'exposition aux rayonnements radiofréquence ainsi qu'au débit d'absorption spécifique maximum autorisé.

Des informations pour les utilisateurs sur la réglementation Canadienne concernant l'exposition aux rayonnements RF sont disponibles sur le site www.ic.gc.ca.

Ce produit a été développé pour fonctionner spécifiquement avec les antennes listées dans le tableau ⇒ [6.1.5 Approved Antenna List](#), présentant un gain maximum de 2.1 dBi (pour 2.4 GHz) et 2.9 dBi (pour 5 GHz). Des antennes autres que celles listées ici, ou présentant un gain supérieur à 2.1 dBi (pour 2.4 GHz) et 2.9 dBi (pour 5 GHz) ne doivent en aucune circonstance être utilisées en combinaison avec ce produit. L'impédance des antennes compatibles est 50 Ω. L'antenne utilisée avec ce produit ne doit ni être située à proximité d'une autre antenne ou d'un autre émetteur, ni être utilisée conjointement avec une autre antenne ou un autre émetteur.

En raison de la taille du produit, l'identifiant IC est fourni dans le manuel d'installation.



Le client final doit s'assurer que l'appareil se trouve en toutes circonstances à une distance de plus de 20 cm du corps humain.

Si le client final envisage une application nécessitant d'utiliser le PAN9028 à une distance inférieure à 20 cm du corps humain, alors le FEO doit répéter l'évaluation DAS.

L'équipement du client final doit répondre aux exigences actuelles de sécurité et de santé selon l'ISED.

6.2.1 Radio Standards Specification RSS-247 Issue 2

The Radio Standards Specification RSS-247, Issue 2, Digital Transmission Systems (DTSs), Frequency Hopping Systems (FHSs) and License-Exempt Local Area Network (LE-LAN) Devices, replaces RSS-247, Issue 1, dated May 2015. It sets out certification requirements for radio apparatus operating in the bands 2 400 MHz to 2 483.5 MHz and 5 725 MHz to 5 850 MHz employing frequency hopping, digital modulation and/or a combination (hybrid) of both techniques. It also includes license exempt local area network (LE-LAN) devices operating in the bands 5 150 MHz to 5 250 MHz, 5 250 MHz to 5 350 MHz, 5 470 MHz to 5 725 MHz and 5 725 MHz to 5 850 MHz as specified in SP-5 150 MHz.

6.2.1.1 General

Equipment covered by the standard RSS-247 is classified as Category I equipment. Either a technical acceptance certificate (TAC) issued by the Certification and Engineering Bureau of Innovation, Science and Economic Development Canada (ISED) or a certificate issued by a certification body (CB) is required.

6.2.1.2 Certification Requirements

RSS-247 shall be used in conjunction with RSS-Gen, General Requirements for Compliance of Radio Apparatus, for general specifications and information relevant to the equipment for which this standard applies. Equipment certified under the standard is required to comply with the provisions in RSS-Gen with respect to emissions falling within restricted frequency bands. These restricted frequency bands are listed in RSS-Gen.

6.2.1.3 Measurement Method

In addition to the requirements in RSS-Gen and the requirements of the standard RSS-247, the method for measuring DTS devices is provided in ANSI C63.10.

6.2.1.4 FHS and DTS operating in the Bands 2 400 MHz to 2 483.5 MHz

This section applies to frequency hopping systems (FHSs) in the bands 2 400 MHz to 2 483.5 MHz and 5 725 MHz to 5 850 MHz and digital transmission systems (DTSs) in the band 2 400 MHz to 2 483.5 MHz. Systems in these bands can be frequency hopping, digital transmission and/or a combination (hybrid) of both types. The digital transmission technology of DTSs or hybrid systems operating in the band 5 725 MHz to 5 850 MHz shall comply with the requirement in section “Technical requirements for license-exempt local area network devices and digital transmission systems operating in the 5 GHz band”.

RSS-247 Section	5.1
Frequency Band (MHz)	2 400 to 2 483.5
Systems	Frequency Hopping Systems
Systems out of Scope	FHS operating in the band 5 725 MHz to 5 850 MHz Fixed point-to-point systems
Requirements	FHSs may have hopping channel carrier frequencies that are separated by 25 kHz or two thirds of the 20 dB bandwidth of the hopping channel, whichever is greater, provided that the systems operate with an output power no greater than 0.125 W. FHSs shall use at least 15 hopping channels. The average time of occupancy on any channel shall not be greater than 0.4 seconds within a period of 0.4 seconds, multiplied by the number of hopping channels employed. Transmissions on particular hopping frequencies may be avoided or suppressed provided that at least 15 hopping channels are used.
Complied Module M/N	ENWF9408A1EF, ENWF9408A2EF

RSS-247 Section	5.2
Frequency Band (MHz)	2 400 to 2 483.5
Systems	Digital Transmission Systems
Systems out of Scope	-
Requirements	<p>The minimum 6 dB bandwidth shall be 500 kHz.</p> <p>The transmitter power spectral density conducted from the transmitter to the antenna shall not be greater than 8 dBm in any 3 kHz band during any time interval of continuous transmission.</p> <p>The maximum peak conducted output power shall not exceed 1 W. The e.i.r.p. shall not exceed 4 W.</p>
Complied Module M/N	ENWF9408A1EF, ENWF9408A2EF

RSS-247 Section	5.3
Frequency Band (MHz)	2 400 to 2 483.5
Systems	Hybrid Systems
Systems out of Scope	Hybrid devices operating in the band 5 725 MHz to 5 850 MHz.
Requirements	<p>With the digital transmission operation of the hybrid system turned off, the frequency hopping operation shall have an average time of occupancy on any frequency not exceeding 0.4 seconds within a duration in seconds equal to the number of hopping frequencies multiplied by 0.4.</p> <p>With the frequency hopping turned off, the digital transmission operation shall comply with the power spectral density requirements for digital modulation systems set out in section "5.2" ⇒ RSS-247 Section.</p>
Complied Module M/N	ENWF9408A1EF, ENWF9408A2EF

RSS-247 Section	5.4
Frequency Band (MHz)	2 400 to 2 483.5
Systems	FHSs operating in the band 2 400 MHz to 2 483.5 MHz. DTSs employing digital modulation techniques operating in the band 2 400 MHz to 2 483.5 MHz.
Systems out of Scope	FHSs operating in the band 902 MHz to 928 MHz and 5 725 MHz to 5 850 MHz. DTSs employing digital modulation techniques operating in the bands 902 MHz to 928 MHz. Fixed point-to-point systems in the bands 2 400 MHz to 2 483.5 MHz and 5 725 MHz to 5 850 MHz. Transmitters operating in the band 2 400 MHz to 2 483.5 MHz, may employ antenna systems that emit multiple directional beams simultaneously or sequentially.
Requirements	Transmitter Output Power: The maximum peak conducted output power shall not exceed 1 W if the hopset uses 75 or more hopping channels; the maximum peak conducted output power shall not exceed 0.125 W if the hopset uses less than 75 hopping channels. The e.i.r.p. shall not exceed 4 W. For DTSs employing digital modulation techniques operating in the band 2 400 MHz to 2 483.5 MHz, the maximum peak conducted output power shall not exceed 1 W. The e.i.r.p. shall not exceed 4 W.
Complied Module M/N	ENWF9408A1EF, ENWF9408A2EF

RSS-247 Section	5.5
Frequency Band (MHz)	2 400 to 2 483.5
System	In any 100 kHz bandwidth outside the frequency band in which the spread spectrum or digitally modulated device is operating.
System out of Scope	-
Requirements	Unwanted Emissions: In any 100 kHz bandwidth outside the frequency band in which the spread spectrum or digitally modulated device is operating, the RF power that is produced shall be at least 20 dB below that in the 100 kHz bandwidth within the band that contains the highest level of the desired power, based on either an RF conducted or a radiated measurement, provided that the transmitter demonstrates compliance with the peak conducted power limits. If the transmitter complies with the conducted power limits based on the use of root-mean-square averaging over a time interval the attenuation required shall be 30 dB instead of 20 dB. Attenuation below the general field strength limits specified in RSS-Gen is not required.
Complied Module M/N	ENWF9408A1EF, ENWF9408A2EF

6.2.1.5 Requirements for LE-LAN and DTS operating in the 5 GHz Band

The section provides standards for Licence-Exempt Local Area Network (LE-LAN) devices operating in the bands:

- 5 150 MHz to 5 250 MHz
- 5 725 MHz to 5 850 MHz

For DTSs operating in the band 5 725 MHz to 5 850 MHz that employ digital modulation technology, but are not designed for LE-LAN operation.

Devices with occupied bandwidths which overlap different bands shall comply with all operational requirements for each band.

RSS-247 Section	6.2.1
Frequency Band (MHz)	5 150 to 5 250
Device Type	LE-LAN devices are restricted to indoor operation only.
Devices out of Scope	OEM devices installed in vehicles.
Power Limits	Maximum e.i.r.p. shall not exceed 200 mW or $10+10 \log_{10}B$, dBm, whichever power is less. B is the 99 % emission bandwidth in megahertz. The e.i.r.p. spectral density shall not exceed 10 dBm in any 1 MHz band.
Unwanted Emission Limits	For transmitters with operating frequencies in the band 5 150 MHz to 5 250 MHz, all emissions outside the band 5 150 MHz to 5 350 MHz shall not exceed -27 dBm/MHz e.i.r.p. Any unwanted emissions that fall into the band 5 250 MHz to 5 350 MHz shall be attenuated below the channel power by at least 26 dB, when measured using a resolution bandwidth between 1 % and 5 % of the occupied bandwidth (i.e. 99% bandwidth), above 5 250 MHz. The 26 dB bandwidth may fall into the 5 250 MHz to 5 350 MHz band; if the occupied bandwidth also falls within the 5 250 MHz to 5 350 MHz band, the transmission is considered as intentional and the devices shall comply with all requirements in the band 5 250 MHz to 5 350 MHz including implementing dynamic frequency selection (DFS) and TPC, on the portion of the emission that resides in the 5 250 MHz to 5 350 MHz band.
Complied Module M/N	ENWF9408A1EF, ENWF9408A2EF

RSS-247 Section	6.2.4
Frequency Band (MHz)	5 725 to 5 850
Device Type	For equipment operating in the band 5 725 MHz to 5 850 MHz
Devices out of Scope	Fixed point-to-point devices and devices with antenna gain greater than 6 dBi.
Power Limits	The minimum 6 dB bandwidth shall be at least 500 kHz. The maximum conducted output power shall not exceed 1 W. The output power spectral density shall not exceed 30 dBm in any 500 kHz band.
Unwanted Emission Limits	Devices shall have e.i.r.p. of unwanted emissions comply with the following: <ul style="list-style-type: none"> • 27 dBm/MHz at frequencies from the band edges decreasing linearly to 15.6 dBm/MHz at 5 MHz above or below the band edges • 15.6 dBm/MHz at 5 MHz above or below the band edges decreasing linearly to 10 dBm/MHz at 25 MHz above or below the band edges • 10 dBm/MHz at 25 MHz above or below the band edges decreasing linearly to -27 dBm/MHz at 75 MHz above or below the band edges • -27 dBm/MHz at frequencies more than 75 MHz above or below the band edges
Complied Module M/N	ENWF9408A1EF, ENWF9408A2EF

6.2.2 IC Notice

English



The device PAN9028 (⇒ [7.1 Ordering Information](#)), including the antennas (⇒ [6.1.5 Approved Antenna List](#)), complies with Canada RSS-GEN Rules. The device meets the requirements for modular transmitter approval as detailed in RSS-Gen.

Operation is subject to the following two conditions:

1. This device may not cause harmful interference, and
2. This device must accept any interference received, including interference that may cause undesired operation.

French



Le présent appareil PAN9028 (⇒ [7.1 Ordering Information](#)), les antennes y compris (⇒ [6.1.5 Approved Antenna List](#)), est conforme aux CNR-Gen d'Industrie Canada applicables aux appareils radio exempts de licence.

L'exploitation est autorisée aux deux conditions suivantes:

1. L'appareil ne doit pas produire de brouillage, et
2. L'utilisateur de l'appareil doit accepter tout brouillage radioélectrique subi, même si le brouillage est susceptible d'en compromettre le fonctionnement.

6.2.3 Labeling Requirements

English



Labeling Requirements

The OEM must ensure that IC labelling requirements are met. This includes a clearly visible label on the outside of the OEM enclosure specifying the appropriate Panasonic IC identifier for this product as well as the IC Notice above.

The IC identifier is **IC: 216Q-9028**.

This IC identifier is valid for all PAN9028 modules ⇒ [7.1 Ordering Information](#). In any case, the end product must be labelled on the exterior with:

"Contains IC: 216Q-9028".

French



Obligations d'étiquetage

Les fabricants d'équipements d'origine (FEO) – en anglais Original Equipment Manufacturer (OEM) – doivent s'assurer que les obligations d'étiquetage IC du produit final sont remplies. Ces obligations incluent une étiquette clairement visible à l'extérieur de l'emballage externe, comportant l'identifiant IC du module Panasonic inclus, ainsi que la notification ci-dessus.

L'identifiant IC est **IC: 216Q-9028**.

Cet identifiant est valide pour tous les modules PAN9028 ⇒ [7.1 Ordering Information](#). Dans tous les cas les produits finaux doivent indiquer sur leur emballage externe la mention suivante:

"Contient IC: 216Q-9028".

6.3 European Conformity According to RED (2014/53/EU)

The PAN9028 modules with model number ENWF9408A1EF and ENWF9408A2EF comply with the standards according to the following LVD (2014/35/EU), EMC-D (2014/30/EU) together with RED (2014/53/EU) articles:

- 3.1a Safety/Health: EN 62368-1:2014
EN 62311:2008
- 3.1b EMC: EN 301 489-1 V2.2.3
EN 301 489-3 V2.1.2 (Draft)
EN 301 489-17 V3.2.4
- 3.2 Radio: EN 300 328 V2.2.2
EN 301 893 V2.1.1
- 3.3d Common Security: EN 18031-1:2024

- Due to the model size, the CE marking is displayed in the installation instruction only and it cannot be displayed conform to regulation (EU) No. 765/2008 in 5 mm height on the module's label due to the limited space.
- The RED EU Type Examination Certificate No. **GOM-2010-9377-V01** issued by the Notified Body 0681 can be used for the OEM end product conformity assessment. If a Notified Body has been contracted for the end product conformity assessment, it should be noted that this EU Type Examination Certificate should be used for conformance assessment.

As a result of the conformity assessment procedure described in 2014/53/EU Directive, the end customer equipment should be labelled as follows:



The requirements for CE marking are described in regulation (EC) No. 765/2008 Annex II.



The end customer has to assure that the device has a distance of more than 20 cm from the human body under all circumstances.

The end customer equipment must meet the actual Safety/Health requirements according to RED. Further analysis must be conducted, as the addition of firmware and other functions requires the evaluation of additional threats and assets.

PAN9028 and its model versions in the specified reference design can be used in all countries of the European Economic Area (Member States of the EU, European Free Trade Association States [Iceland, Liechtenstein, Norway]), Monaco, San Marino, Andorra, and Turkey.

6.3.1 Radio Equipment Directive

The Radio Equipment Directive 2014/53/EU (RED) establishes a regulatory framework for placing radio equipment on the market. It ensures a Single Market for radio equipment by setting essential requirements for safety and health, electromagnetic compatibility, and the efficient use of the radio spectrum.

The RED aligned the previous Directive, the Radio and Telecommunication Terminal Equipment Directive 1999/5/EC (R&TTED), with the new legislative framework for the marketing of products. The RED is applicable as of 2016-06-13. It included a one-year transitional period, which ended on 2017-06-12 (Article 48). On 2017-06-20, the Commission Implementing Regulation (EU) 2017/1354 was adopted. This specifies how to present the information provided for in Article 10(10) of Directive 2014/53/EU.

Article 10(10) RED

In cases of restrictions on putting into service or of requirements for authorisation of use, information available on the packaging shall allow the identification of the Member States or the geographical area within a Member State where restrictions on putting into service or requirements for authorisation of use exist. Such information shall be completed in the instructions accompanying the radio equipment. The Commission may adopt implementing acts specifying how to present that information. Those implementing acts shall be adopted in accordance with the advisory procedure referred to in Article 45(2).

- **Class 1:**
Radio equipment that can be operated without any restriction in EU, EEA, and EFTA. According to Article 8(1)b of the RED, it is clarified that no national radio interfaces specifications are required to be notified under RED;
- **Class 2:**
Radio equipment subject to restrictions in one or more EU, EEA, and EFTA countries where:
 - The technical parameters are not harmonised through EU, EEA, and EFTA;
 - The technical parameters are harmonised through EU, EEA, and EFTA, and do not fall in above class 1 definition.

Radio equipment class means a class identifying particular categories of radio equipment which, under this Directive, are considered similar and those radio interfaces for which the radio equipment is designed.

Article 8 RED

Notification of radio interface specifications and assignment of radio equipment classes 1:

- 1) Member States shall notify, in accordance with the procedure set out in Directive 98/34/EC, the radio interfaces which they intend to regulate except:
 - a) The radio interfaces which fully and without any deviation comply with the Commission decisions on the harmonised use of radio spectrum adopted pursuant to Decision No. 676/2002/EC; and
 - b) The radio interfaces which, in accordance with implementing acts adopted pursuant to paragraph 2 of this Article, correspond to radio equipment which can be put into service and used without restrictions within the Union.
- 2) The Commission shall adopt implementing acts establishing the equivalence between notified radio interfaces and assigning a radio equipment class, details of which shall be published in the Official Journal of the European Union. Those implementing acts shall be adopted in accordance with the examination procedure referred to in Article 45(3).

The Radio Interface Specifications Templates are provided for information in the EFIS database for applications which use is in harmonised radio spectrum, however with restrictions.

6.3.2 Equipment Classes

The PAN9028 is a radio module classified as class-1 or class-2 radio equipment depending on the frequency band in which it can operate. This equipment class is passed on the end-product which integrates the module.

Class 1

Class 1 radio equipment can be placed on the market and put into service without restrictions according to Article 1(3) of Commission Decision 2000/299/EC (Version 2018-01).

This radio module is defined as Class 1 radio equipment when it is restricted to operate in the following frequency bands:

Sub-class of Class 1	Application/Reference	Frequency Band (MHz)	Transmit Power/Power Density
22	Wideband Data Transmission Systems EN 300 328	2 400 to 2 483.5	100 mW e.i.r.p and 100 mW/100 kHz e.i.r.p. density applies when frequency hopping modulation is used, 10 mW/MHz e.i.r.p. density applies when other types of modulation are used.
43	Non-Specific Short Range Devices EN 300 440	5 725 to 5 875	25 mW e.i.r.p.

Class 2

Class 2 radio equipment are restricted in accordance with Article 1(3) of Commission Decision 2000/299/EC1 if the equipment falls within the scope of Class 2.



The usage of PAN9028 module in a vehicular environment cannot be considered as **indoor use**.

This radio module is also defined as Class 2 radio equipment when it is restricted to operate in the following frequency bands:

Sub-class of Class 2	Application/Reference	Frequency Band (MHz)	Transmit Power/Power Density
H01	Wireless Access Systems including Radio Local Area Networks (WAS/RLANs) Restricted to indoor use EN 301 893	5 150 to 5 250	Max. 200 mW mean e.i.r.p. and max. 10 mW/MHz mean e.i.r.p. density in any 1 MHz band.

6.4 United Kingdom Conformity According to Statutory Instrument SI 2017/1206

All modules described in this Product Specification comply with the designated standards according to the following regulations: Electrical Equipment (Safety) SI 2016/1101, EMC SI 2016/1091 together with Radio Equipment Regulation 2017 (RER) SI 2017/1206:

Safety/Health: EN 62368-1: 2014/AC: 2015/A11: 2017 EN 62479: 2010

EMC: EN 301 489-1 V2.2.3: (2019-11)
EN 301 489-17 V3.2.2: (2019-02)

Radio: EN 300 328 V2.2.2: (2019-07)

- Due to the model size, the UK marking is displayed in the installation instruction only and it cannot be displayed conform to SI 2017/1206 on the module's label due to the limited space.
- The RED EU Type Examination Certificate No. **T818987P-01** issued by the EU Notified Body 0681 can be used for the OEM end product conformity assessment. If a Notified Body has been contracted for the end product conformity assessment, it should be noted that this EU Type Examination Certificate should be used for conformance assessment.

As a result of the conformity assessment procedure described in SI 2017/1206 Directive, the end customer equipment should be labelled as follows:



Restrictions or Requirements in the UK

The end customer has to assure that the device has a distance of more than 20 cm from the human body under all circumstances.

If the end customer application intends to use the PAN9028 in a distance smaller 20 cm from the human body, SAR evaluation has to be repeated by the OEM.

The end customer equipment must meet the actual Safety/Health requirements according to SI 2017/1206.

PAN9028 and its model versions in the specified reference design can be used in the UK.

6.5 Bluetooth

The PAN9028 series modules are Bluetooth qualified as "Controller Subsystem".

Qualified Design ID's listed for the Module

Bluetooth	Project Name	Power Class	Model	Declaration ID	QDID
Controller Subsystem	PAN9028	1	ENWF940xA[x]EF	D052581	172842

If the module is combined with a host stack that is Bluetooth qualified as "Host Subsystem" it is possible to list an "End Product" without any further qualification tests.



The OpenSynergy Bluetooth software is commercially available and is delivered in source code format. Applications that are built using the Blue SDK are executed in Linux user space making development easy. The stack software and profiles are qualified components and are listed on the Bluetooth SIG website.

- Blue SDK v6.x and Low Energy SDK v3.x: QDID 120439
- Bluetooth traditional profiles: QDID 117748

Bluetooth Marks

According to the Bluetooth SIG, the PAN9028 fulfills the criteria to label your product as a Bluetooth device:



For further information please refer to the Bluetooth website www.bluetooth.com.

6.6 RoHS and REACH Declaration

The latest declaration of environmental compatibility (Restriction of Hazardous Substances, RoHS and Registration, Evaluation, Authorisation and Restriction of Chemicals, REACH) for supplied products can be found on the Panasonic website in the “Downloads” section of the respective product ⇒ [7.2.2 Product Information](#).

7 Appendix

7.1 Ordering Information

Variants and Versions

Order Number	Brand Name	Description	MOQ ¹⁹
ENWF9408A1EF ²⁰	PAN9028	Wi-Fi/Bluetooth radio module IEEE 802.11 a/b/g/n/ac Bluetooth/Bluetooth LE 5.2 with a ceramic chip-antenna, multi-region version certified for US, EU, and CA ²¹	500
ENWF9408A2EF ²⁰	PAN9028	Wi-Fi/Bluetooth radio module IEEE 802.11 a/b/g/n/ac Bluetooth/Bluetooth LE 5.2 with a ceramic chip-antenna, without PMIC PM823, multi-region version certified for US, EU, and CA ²¹	500
ENWF9408AWEF	PAN9028-MSD	PAN9028 MicroSD Adapter with module ENWF9408A1EF	NRD ²²
ENWF9408AVEF	PAN9028-MSDU	PAN9028 MicroSD-UART Adapter with module ENWF9408A1EF	1
ENWF9408AMEF	PAN9028-M2E-EVD	M.2 Evaluation Board with module PAN9028 and PMIC (ENWF9408A1EF)	1

¹⁹ Abbreviation for Minimum Order Quantity (MOQ). The default MOQ for mass production is 500 pieces, fewer only on customer demand. Samples for evaluation can be delivered at any quantity via the distribution channels.

²⁰ Samples are available on customer demand.

²¹ The multi-region version is restricted to FCC, European ETSI, and Canadian ISED regulatory domain with blocked Tx power table, which is stored on the OTP memory of device. The device does not support the channels 12 to 13 in the 2.4 GHz band. DFS and passive scanning mechanism are not necessary as only the non-DFS channels in the 5 GHz band are supported.

²² Not recommended for new design

7.2 Contact Details

7.2.1 Contact Us

Please contact your local Panasonic Sales office for details on additional product options and services:

For Panasonic Sales assistance in the **EU**, visit

<https://eu.industrial.panasonic.com/about-us/contact-us>

Email: wireless.connectivity@eu.panasonic.com

For Panasonic Sales assistance in **North America**, visit the Panasonic website

“Sales & Support” to find assistance near you at

<https://na.industrial.panasonic.com/distributors>

For information about evaluation tools, schematics, software development, and more, please visit the “Panasonic Wireless Connectivity Development Hub”

<https://pideu.panasonic.de/development-hub/>.

7.2.2 Product Information

Please refer to the Panasonic Wireless Connectivity website for further information on our products and related documents:

For complete Panasonic product details in the **EU**, visit

<https://industry.panasonic.eu/>

For complete Panasonic product details in **North America**, visit

<http://www.panasonic.com/rfmodules>